

# PENTAX

# WG-8

# Operating Manual

The serial number is located inside the battery/card cover.

## Chapter 1: Introduction

**Read this chapter before use.**

This chapter gives you an overview of the PENTAX WG-8.

## Chapter 2: Getting Started

**Read this chapter before using the PENTAX WG-8 for the first time.**

This chapter explains about basic operations such as turning the camera on, performing shooting, and playing back images.

## Chapter 3 and later

**Read these chapters when you want to learn more about the different camera functions.**

These chapters explain about shooting and playback functions, as well as how to customize the camera settings and use it with a computer.

**Model: R08050**

## Regarding User Registration

Thank you for purchasing the PENTAX WG-8.

In order to provide you with the best customer support and service experience for the product you have purchased, we ask you to complete the user registration.

Visit the following website to complete the user registration.

**<https://www.ricoh-imaging.com/registration/>**

Registered users will be notified by e-mail about important customer support information, such as firmware version updates, etc.

# Introduction

This Operating Manual provides information on how to use the shooting and playback functions of this camera and related precautions.

Thoroughly read this Operating Manual to make the best use of the functions available with this camera. Be sure to keep this Operating Manual for future reference.

It is recommended to update the camera firmware to the latest version before using the camera.

For details on the latest firmware version, refer to the following firmware download site.  
<https://www.ricoh-imaging.co.jp/english/>

RICOH IMAGING COMPANY, LTD.

Safety precautions	Read all safety precautions thoroughly to ensure safe use.
Test shots	Take test shots to ensure that the camera is working properly before taking pictures on important occasions.
Copyright	Reproduction or alteration of copyrighted documents, magazines, and other materials, other than for personal, home, or other similarly limited purposes, without the consent of the copyright holder, is prohibited.
Exemption from liability	RICOH IMAGING COMPANY assumes no liability for failure to record or display images as a result of product malfunction.
Radio interference	Operating this camera in the vicinity of other electronic equipment may adversely affect both the camera and the other device. Interference is particularly likely if the camera is used in close proximity to a radio/TV receiver. In such case, take the following measures. <ul style="list-style-type: none"><li>• Keep the camera as far away as possible from the radio/TV receiver.</li><li>• Reorient the antenna of the radio/TV receiver.</li><li>• Use a different wall outlet.</li></ul>

This publication may not be reproduced in whole or in part without RICOH IMAGING COMPANY's express written permission.

© RICOH IMAGING COMPANY, LTD. 2024

RICOH IMAGING COMPANY reserves the right to change the contents of this manual at any time without prior notice.

Every effort has been made to ensure the accuracy of the information in this manual. Should you nevertheless notice any errors or omissions, we would be grateful if you would notify us at the address listed on the back cover of this manual.

## Trademarks

- Microsoft, Windows, and Microsoft Teams are registered trademarks of Microsoft Corporation in the United States of America and other countries.
  - Skype is a registered trademark or trademark of Microsoft Corporation in the United States of America and other countries.
  - The Skype name and associated trademarks are trademarks of Skype or related entities.
  - Mac, macOS, and OS X are trademarks of Apple Inc., registered in the U.S. and other countries.
  - SDXC Logo is a trademark of SD-3C, LLC.
  - FlashAir is a trademark of KIOXIA Corporation.
  - USB Type-C is a trademark of USB Implementers Forum.
  - HDMI, the HDMI logo, and High-Definition Multimedia Interface are trademarks or registered trademarks of HDMI Licensing, LLC in the United States and/or other countries.
  - Facebook Messenger is a registered trademark or trademark of Facebook, Inc.
  - Google Meet is a registered trademark or trademark of Google LLC in the United States of America and other countries.
  - Cisco Webex is a registered trademark or trademark of Cisco Systems, Inc. in the United States of America and other countries.
  - Zoom is a registered trademark or trademark of Zoom Video Communications, Inc. in the United States of America and other countries.
- All other trademarks are the property of their respective owners.
- This product uses the RICOH RT font designed by RICOH COMPANY, LTD.

### **AVC Patent Portfolio License**



This product is licensed under the AVC Patent Portfolio License for the personal use of a consumer or other uses in which it does not receive remuneration to (i) encode video in compliance with the AVC standard ("AVC video") and/or (ii) decode AVC video that was encoded by a consumer engaged in a personal activity and/or was obtained from a video provider licensed to provide AVC video. No license is granted or shall be implied for any other use. Additional information may be obtained from Via Licensing Alliance.

See: <https://www.via-la.com/>

# Safety Precautions

## Warning Symbols

Various symbols are used throughout this Operating Manual and on the product to prevent physical harm to you or other people and damage to property. The symbols and their meanings are explained below.



 <b>Danger</b>	This symbol indicates matters that may lead to imminent risk of death or serious injury if ignored or incorrectly handled.
 <b>Warning</b>	This symbol indicates matters that may lead to death or serious injury if ignored or incorrectly handled.
 <b>Caution</b>	This symbol indicates matters that may lead to injury or property damage if ignored or incorrectly handled.

## Meaning of Symbols



The  symbol alerts you to actions that must be performed.



The  symbol alerts you to prohibited actions. The  symbol may be combined with other symbols to indicate that a specific action is prohibited.

Example:

: Do not touch   : Do not disassemble

Observe the following precautions to ensure safe use of this camera.



## Danger



- Do not attempt to disassemble, repair, or alter the camera yourself. The high-voltage circuitry in the equipment poses significant electrical hazard.



- Do not attempt to disassemble, alter, or directly solder the battery.



- Do not put the battery in a fire, attempt to heat it, or use or leave it in a high temperature environment such as next to a fire or inside a car. Do not put it into water or the sea or allow it to get wet.



- Do not attempt to pierce, hit, compress, drop, or subject the battery to any other severe impact or force.



- Do not use a battery that is significantly damaged or deformed.

## Warning



- Turn off the power immediately in the event of abnormalities such as smoke or unusual odors being emitted. Remove the battery as soon as possible, being careful to avoid electric shocks or burns. If you are drawing power from a household electrical outlet, be sure to unplug the power plug from the outlet. Failure to observe this precaution could result in fire or electric shocks. Contact the nearest service center at your earliest convenience. Stop using the camera immediately if it is malfunctioning.



- Turn off the power immediately if any metallic object, water, liquid, or other foreign object gets into the camera. Remove the battery and memory card as soon as possible, being careful to avoid electric shocks or burns. If you are drawing power from a household electrical outlet, be sure to unplug the power plug from the outlet. Failure to observe this precaution could result in fire or electric shocks. Contact the nearest service center at your earliest convenience. Stop using the camera immediately if it is malfunctioning.



- If the monitor is damaged, avoid any contact with the liquid crystal inside it. Follow the appropriate emergency measures below.
- SKIN: If any of the liquid crystal gets on your skin, wipe it off and rinse the affected area thoroughly with water, then wash well with soap.
- EYES: If it gets in your eyes, wash your eyes with clean water for at least 15 minutes and seek medical advice immediately.
- INGESTION: If any of the liquid crystal is ingested, rinse the mouth out thoroughly with water. Have the person drink a large amount of water and induce vomiting. Seek medical assistance immediately.



- Follow these precautions to prevent the battery from leaking, overheating, igniting, or exploding.
- Do not use a battery other than those specifically recommended for the camera.
- Do not carry or store the battery together with metal objects such as ball-point pens, necklaces, coins, and hairpins.
- Do not put the battery into a microwave or high pressure container.
- If leakage of battery fluid, a strange odor, color change, etc. is noticed during use or during charging, remove the battery from the camera or battery charger immediately and keep it away from fire.



- Observe the following in order to prevent fire, electrical shock, or cracking of the battery while charging.
- Use only the indicated power supply voltage. Also avoid the use of multi-socket adapters and extension cords.
- Do not damage, bundle, or alter the AC plug cord. Also, do not place heavy objects on, stretch, or bend the AC plug cord.
- Do not connect or disconnect the power plug with wet hands. Always grip the plug section when disconnecting a power plug. Do not cover the camera while charging the battery.



- Keep the battery and SD memory card used in the camera out of the reach of children to prevent accidental swallowing. The battery and memory card are harmful if swallowed. Seek medical assistance immediately.



- Keep the camera out of the reach of children. For children, accidents may occur because they cannot understand the contents of "Safety Precautions" and "Precautions for Use".



- Do not touch the internal components of the camera if they become exposed as a result of being dropped or damaged. The high-voltage circuitry in the equipment could lead to electric shocks. Remove the battery as soon as possible, being careful to avoid electric shocks or burns. Take the camera to your nearest dealer or service center if it is damaged.



- When using the camera in wet areas such as a kitchen, be careful not to wet the inside of the camera. Failure to observe this precaution could result in fire or electric shocks.



- Do not use the camera near flammable gases, gasoline, benzene, thinner, or similar substances. Failure to observe this precaution could result in an explosion, fire, or burns.
- Do not use the camera in a location where usage is restricted or prohibited, such as on airplanes. Failure to observe this precaution could result in an accident.



- Wipe off any dust that accumulates on the power plug. Failure to observe this precaution could result in fire.
- When using a household power outlet, always use the dedicated AC adapter. Failure to observe this precaution could result in fire, electric shocks, or product malfunction.



- Do not use the battery charger or AC adapter with commercially available electronic transformers when traveling abroad. Failure to observe this precaution could result in fire, electric shocks, or product malfunction.

 **Caution**



- Contact with fluid leaking from a battery can lead to burns. If part of your body comes in contact with a damaged battery, rinse the area with water immediately. (Do not use soap.)

If a battery starts to leak, remove it immediately from the camera and wipe the battery chamber thoroughly before replacing it with a new battery.



- Plug the power plug securely into the electrical outlets. Failure to observe this precaution could result in fire.



- Do not allow the camera interior to get wet. When operating the camera with wet hands, be careful not to get the camera interior wet. Failure to observe this precaution could result in electric shocks.



- Do not fire the flash at drivers of vehicles, as this may cause the driver to lose control and result in a traffic accident. Failure to observe this precaution could result in a traffic accident.



- Do not replace the battery with an incorrect type. Failure to observe this precaution could defeat a safeguard (for example, in the case of some lithium battery type).



- Do not dispose of the battery into fire or a hot oven, or mechanically crush or cut the battery. Failure to observe this precaution could result in an explosion.



- Do not leave the battery in an extremely high temperature surrounding environment. Failure to observe this precaution could result in an explosion or leakage of flammable liquid or gas.



- Do not subject the battery to extremely low air pressure. Failure to observe this precaution could result in an explosion or leakage of flammable liquid or gas.

**Safety Precautions  
for Accessories**

When using optional products, carefully read the user's manuals provided with the product before using that product.



# Contents

---

Introduction .....	1
Safety Precautions .....	3
<b>1 Introduction</b> .....	<b>11</b>
Checking the Contents of the Package .....	11
Names and Functions of the Working Parts .....	12
Operating Controls .....	14
Indicators on the Monitor .....	16
Shooting Screen .....	16
Playback Screen .....	17
Changing the Screen Display .....	18
How to Change Function Settings .....	19
Using the Button .....	19
Setting from the Menus .....	22
Menu List .....	24
📷 Shooting Menu .....	24
🎬 Movie Menu .....	25
▶ Playback Menu .....	26
⚙️ Customize Menu .....	27
🔧 Setup Menu .....	29
<b>2 Getting Started</b> .....	<b>31</b>
Setting the Battery and a Memory Card .....	31
Inserting the Battery and a Memory Card .....	31
Charging the Battery .....	33
Initial Settings .....	35
Turning the Camera On .....	35
Setting the Language and the Date and Time .....	36
Formatting a Memory Card .....	37
Basic Shooting Operation .....	38
Shooting in the Auto Mode .....	38
Viewing the Captured Images .....	39
<b>3 Shooting</b> .....	<b>40</b>
Taking Still Images .....	40
Setting the Capture Mode .....	40
Using Exposure Compensation .....	43
Recording Movies .....	44
Playing Back Movies .....	46

Using the Camera as a Webcam .....	47
Installing the Camera .....	47
Setting the Focus Mode .....	49
Focusing Manually (Manual Focus) .....	51
Setting the Exposure .....	52
Selecting a Metering Method .....	52
Setting the ISO Sensitivity .....	53
Using the Flash .....	54
Setting the White Balance .....	56
Setting the White Balance Manually .....	57
Setting the Drive Mode .....	58
Shooting Using the Self-timer .....	58
Shooting Continuously .....	59
Shooting Using the Remote Control Unit .....	60
Shooting with Varied Exposure Values .....	61
Configuring the Capture Settings .....	62
Image Capture Settings .....	62
Movie Capture Settings .....	62
Setting the Image Finishing Tone and Correction .....	63
Setting the Image Atmosphere (Image Tone) .....	63
Setting the Sharpness, Saturation, Tone, and Contrast .....	64
Imprinting the Date on Still Images .....	64
Taking Images with Clearer Details .....	64
Correcting a Range of Tones (D-Range Setting) .....	65
Reducing Blurring of Images .....	65

## **4 Playback Functions 66**

---

Changing the Playback Method .....	66
Displaying Multiple Images .....	66
Playing Back Images Continuously (Slideshow) .....	67
Displaying Rotated Images .....	68
Connecting the Camera to an AV Device .....	69
Organizing Files .....	70
Deleting Files .....	70
Copying Images .....	71
Protecting Images from Deletion .....	72
Copying Images to a Computer .....	73
Editing and Processing Images .....	74
Changing the Image Size .....	74
Processing Images with Filters .....	76

Editing Movies .....	77
Correcting Red Eyes in Images .....	79

## **5 Changing the Settings** **80**

---

Saving Frequently Used Settings .....	80
Using the Mode Dial .....	80
Exporting the Settings to a File .....	81
Customizing the Button Functions .....	82
Registering Functions to the Movie Button .....	82
Changing the Functions of the Green Button .....	83
Display and Sound Settings .....	84
Setting the Start-up Screen .....	84
Setting the Information Displayed when the Camera Is Turned On/Off .....	84
Setting the Live View Display .....	84
Setting the Brightness of the Monitor .....	85
Setting the Lamp .....	85
Setting the Sound Volume .....	85
Power Saving Settings .....	86
Automatically Turning the Power Off .....	86
Dimming the Display .....	86
Setting the GPS .....	88
Displaying the GPS Information .....	89
Automatically Adjusting the Date and Time Settings .....	90
Recording the Camera Route .....	90
Setting the Direction Information .....	92
Imprinting the GPS Information .....	93
File Management Settings .....	94
Specifying the Folder/File Settings .....	94
Setting the Copyright Information .....	97
Saving the Local Date and Time of the Specified City .....	99

## **6 Appendix** **100**

---

Attaching Optional Accessories .....	100
Wide Conversion Lens .....	100
AC Adapter .....	101
Troubleshooting .....	102
Power Supply .....	102
Shooting .....	103
Playback/Deletion .....	105

Others .....	106
Error Messages.....	107
<b>Main Specifications.....</b>	<b>108</b>
Camera .....	108
USB Power Adapter AC-U2.....	111
Rechargeable Battery DB-110 .....	111
Image Storage Capacity .....	112
Operating Environment .....	113
Using the Camera Abroad .....	114
Precautions for Use .....	115
Camera Care and Storage.....	118
Warranty Policy.....	120
Regulatory Compliance Statements.....	123
Index.....	133

## Checking the Contents of the Package

Before using your digital camera, confirm that the package contains the items listed below.



**PENTAX WG-8**

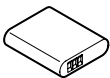

**Rechargeable  
battery (DB-110)**

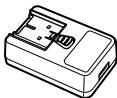

**USB power  
adapter (AC-U2)**



**Power plug**



**Macro stand  
(O-MS3)**

- **USB cable (I-USB173)**
- **Hand strap (O-ST104)**
- **Operating Manual (this manual)**
- **Regarding Waterproof Design**



### **Macro Stand**-----

- The macro stand is used to keep a distance of 1 cm between the lens and the subject. Attach the macro stand to the camera by screwing it into the lens. You can use it in capture modes such as the digital microscope mode. (p.40)
- When the macro stand is attached to the camera, it may be difficult to focus on the subject depending on the type of subject.

# Names and Functions of the Working Parts

1

Introduction

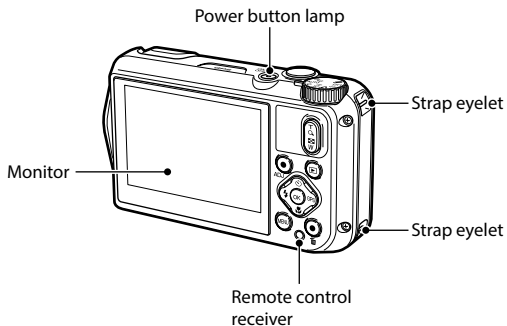
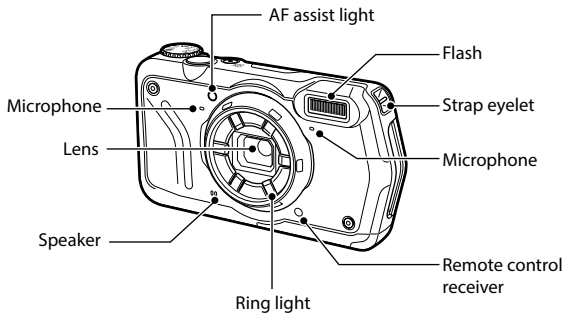

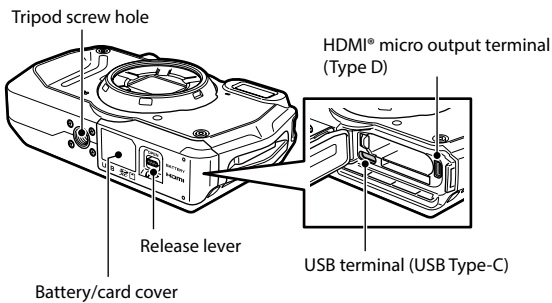

## Operating Controls

This section explains about operating controls.

The icons in parentheses are used in the descriptions of this manual.

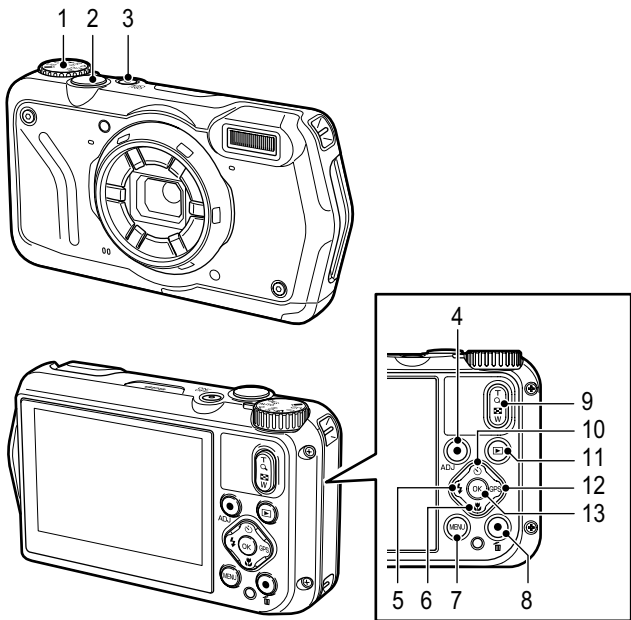

**1 Mode dial**

Changes the capture mode. (p.40)

**2 Shutter release button (SHUTTER)**















Press to capture images.

Press halfway to activate autofocus. (p.38)

**3 Power button**

Turns the power on or off. (p.35)



- 4 Movie/ADJ. button**  
In the still image mode, press to start and end the movie recording. (p.44)  
Calls ADJ. mode functions when the functions are assigned to the button. (p.20)
- 5 Flash/Left button (  /  )**  
Changes the flash mode. (p.54)  
Moves the cursor to the left when an item is selected.
- 6 Focus/Down button (  /  )**  
Changes the focus mode. (p.49)  
Moves the cursor down when an item is selected.
- 7 MENU button (  )**  
Displays a menu. Press this button while the menu is displayed to return to the previous screen. (p.22)
- 8 Green/Delete button (  )**  
Press to perform shooting in the green mode. (p.40)  
When a function is assigned to the button, press to call the assigned function. (p.21)  
In the playback mode, press to delete images. (p.39)
- 9 Zoom button (  (T) /  (W) )**  
Changes the zoom magnification. (p.38)
- 10 Drive/Up button (  /  )**  
Changes the drive mode. (p.58)  
Moves the cursor up when an item is selected.
- 11 Playback button (  )**  
Switches between the shooting mode and the playback mode. (p.39)
- 12 GPS/Right button (  /  )**  
Press and hold to turn the GPS function on or off. (p.89)  
Moves the cursor to the right when an item is selected.
- 13 OK button (  )**  
Switches the information displayed on the shooting screen and playback screen. (p.18)  
Confirms the selected items when setting a function.

# Indicators on the Monitor

## Shooting Screen

1

Introduction

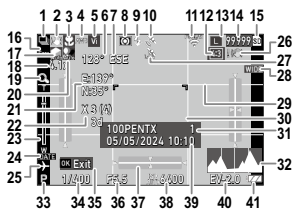

Still image mode



Movie mode

- |    |   |    |  |
|----|---|----|--|
| 1  | Drive mode (p.58)                               | 23 | Zoom bar/Focus bar (p.38, p.51)                    |
| 2  | Motion blur reduction/Movie SR (p.65)           | 24 | Date imprint (p.64)                                |
| 3  | Focus mode (p.49)                               | 25 | World time (p.99)                                  |
| 4  | White balance (p.56)                            | 26 | Camera shake warning                               |
| 5  | Image tone (p.63)                               | 27 | GPS lock (p.90)                                    |
| 6  | Electronic compass information (azimuth) (p.92) | 28 | Conversion lens (p.100)                            |
| 7  | Electronic compass direction                    | 29 | Grid guide (p.84)                                  |
| 8  | AE metering (p.52)                              | 30 | Focus frame  |
| 9  | Flash mode (p.54)                               | 31 | Save destination folder (p.94)/<br>Number of files |
| 10 | GPS positioning status (p.89)                   | 32 | Histogram  |
| 11 | FlashAir communication status (p.32)            | 33 | Capture mode (p.40)                                |
| 12 | Aspect ratio (p.62)                             | 34 | Shutter speed                                      |
| 13 | Recorded pixels (p.62)                          | 35 | Operation guide                                    |
| 14 | Number of storable images                       | 36 | Aperture value                                     |
| 15 | Storage location (p.32)                         | 37 | Electronic level (p.84)                            |
| 16 | Face detection (p.50)                           | 38 | ISO setting (p.52)                                 |
| 17 | Highlight correction (p.65)                     | 39 | Date and time (p.36)                               |
| 18 | Zoom magnification (p.38)                       | 40 | Exposure compensation (p.43)                       |
| 19 | Digital zoom (p.39)                             | 41 | Battery level (p.17)                               |
| 20 | Shadow correction (p.65)                        | 42 | Recording indicator                                |
| 21 | GPS information (p.89)                          | 43 | Recording time/Remaining recording time            |
| 22 | GPS positioning quality                         |    |  |

# Playback Screen

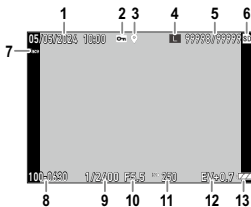

Still image mode

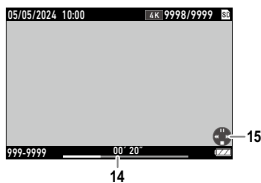

Movie mode

- |   |                                  |    |   |
|---|----------------------------------|----|---|
| 1 | Shooting date and time           | 9  | Shutter speed   |
| 2 | Image protection (p.72)          | 10 | Aperture value  |
| 3 | GPS information (p.89)           | 11 | ISO setting   |
| 4 | Recorded pixels (p.62)           | 12 | Exposure compensation                                 |
| 5 | Current file/Total files         | 13 | Battery level (p.17)                                  |
| 6 | Data source                      | 14 | Length of time of the recorded movie/<br>Elapsed time |
| 7 | Face detection (p.50)            | 15 | Operation guide                                       |
| 8 | Folder number/File number (p.94) |    |   |

## Battery Level

The icon display changes depending on the battery level.

	The battery level is sufficient.
	The battery level started to drop.
	The battery level is low. Charge the battery.
	The camera will turn off soon.
	There is a problem with the battery.

## Changing the Screen Display

You can switch the information displayed on the screen by pressing **OK**.

### Shooting Mode

The information displayed on the shooting screen can be switched.

Standard information display	Displays the standard information such as shooting settings and electronic level.
Detailed information display	Displays the standard information, electronic compass information, and GPS information.
Grid guide display	Displays the grid guide.
No information display	Displays the autofocus frame during range-finding.
Display off	Displays the autofocus frame and Live View only when <b>SHUTTER</b> is pressed halfway.



#### Memo

- The grid style can be selected in [Grid Guide Display Op.] of the **C** menu. (p.84)

### Playback Mode

You can switch the screen display among “Standard information display”, “Detailed information display”, and “No information display” in the single image display.

Use **▲▼** to switch the page in “Detailed information display”.

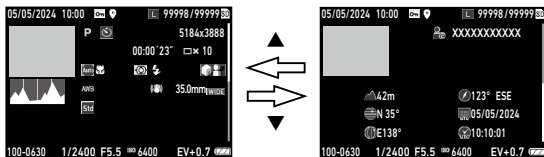

#### Memo

- The displayed information differs between still images and movies.

# How to Change Function Settings

## Using the Button

### Using the Direct Keys

Quick settings are possible by pressing ▲▼◀▶ in the shooting mode. The following functions can be activated.

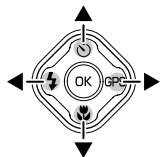

▲ (📷)	Drive Mode (p.58)
▼ (🔍)	Focus Mode (p.49)
◀ (⚡)	Flash Mode (p.54)
Press and hold ▶ (GPS)	GPS On/Off (p.89)



#### Memo

- The functions mentioned above can be set from the menu by pressing **MENU**.

## Using the ADJ. Mode

The functions assigned to the movie button in [ADJ Button Setting 1] to [ADJ Button Setting 5] of the **C** menu can be easily recalled. (p.82)

### 1 Set [Movie Button] to [Off] in the **C** menu.

The ADJ. mode is enabled.

### 2 Press the movie button in the shooting mode.

The mode switches to the ADJ. mode and the icons for the assigned functions appear.

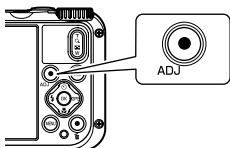

### 3 Use **◀▶** to select a function.

The five functions assigned to the button can be selected.



### 4 Press **OK**.

The selected function is set and the camera is ready to perform shooting.



#### Caution

- By default, the movie button functions as the button to start and end the movie recording. When recording movies with the movie button, set [Movie Button] to [On] in the **C** menu. (p.44)

## Using the Green Button

The assigned function can be activated by pressing the green button in the shooting mode.

By default, [Green Mode] is assigned to the button. You can perform shooting in the green mode by pressing the button. (p.40)

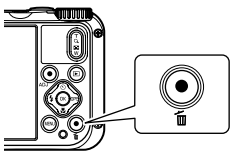

### Memo

- The function of the green button can be changed in [Green Mode] of the **C** menu. (p.83)

## Setting from the Menus

Most functions are set from the menus.

### 1 Press **MENU**.

The menu appears.

The menu displayed differs depending on the camera status.

### 2 When changing the menu type, press **◀**, and use **▲▼** to select a type.

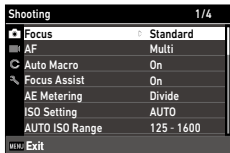

	Shooting menu (p.24) This menu is displayed only in the shooting mode.
	Movie menu (p.25) This menu is displayed only in the shooting mode.
	Playback menu (p.26) This menu is displayed only in the playback mode.
	Customize menu (p.27)
	Setup menu (p.29)

### 3 Press **▶**.

### 4 Use **▲▼** to select a function to set, and press **▶**.

The settings for the selected setting item are displayed.

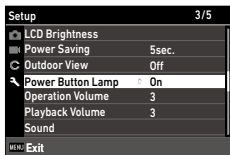

### 5 Use **▲▼** to select a setting, and press **OK**.

The screen in Step 4 reappears.

Press **MENU** to return to the previous screen.

When you have finished setting, press **MENU** several times to return to previous screens.

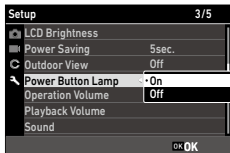





## Memo

---

- When **MENU** is pressed, the first screen of the menu or menu appears. To display the last used menu screen first, set [Cursor Pos. Keeping] to [On] in the menu.
- The setting is saved even after the power is turned off. To reset the menu settings, select a menu type to reset in [Initialized Setting] of the menu, and execute [Reset] in the menu.

## Menu List

The following menus are available. (The underlined settings and the square-bracketed settings are the default settings.)

### Shooting Menu

Focus	<u>Standard</u> , Macro, 1cm Macro, PF, Infinity, MF	p.49
AF	<u>Multi</u> , Spot, Tracking	p.50
Auto Macro	<u>On</u> , Off	p.49
Focus Assist	<u>On</u> , Off	p.50
AE Metering	<u>Divide</u> , Center, Spot	p.52
ISO Setting	<u>AUTO</u> , 125 to 6400	p.53
AUTO ISO Range	125 - 200, 125 - 400, 125 - 800, <u>125 - 1600</u> , 125 - 3200, 125 - 6400	
EV Comp.	-2.0 to +2.0	p.43
Flash Mode	<u>Auto</u> , Flash Off, Flash On, Auto+R. eye, On+Red-eye, Ring Light	p.54
White Balance	<u>Auto WB</u> , Daylight, Shade, Cloudy, Fl. DL Color, Fl. DL White, Fl. Cool Wt., Fl. Warm Wt., Tungsten, Ring Light, Manual WB	p.56
Pix. Track SR	On, <u>Off</u>	p.65
Face Detection	On, Smile, Assist, Assist+Smile, Off	p.50
Blink Detection	<u>On</u> , Off	p.38
Digital Zoom	<u>On</u> , Off	p.39
Drive Mode	<u>Off</u> , Self-timer, Cont. Shoot, Burst Shoot, M-Cont, S-Cont, Remote Ctl, A-Bracket	p.58
Ring Light	Select: <u>All</u> , Right, Left, High, Low, Off Brightness: 1 to 9 [5] LightningTime: Always On, <u>Shutter 10s</u> , Shutter 20s, Shutter 30s, Shutter 60s	p.55
Recorded Pixels	<u>L</u> , M, S, XS, VGA	p.62
Aspect Ratio	<u>4:3</u> , 3:2, 1:1	
Quality Level	☆☆☆☆, ☆☆☆, ☆	
Image Tone	<u>Bright</u> , Natural, Vibrant, Slide Film, Monochrome	
D-Range Setting	Highlight Cor.: Auto, Off Shadow Cor.: <u>Auto</u> , Off	p.65

Sharpness	Soft, <u>Standard</u> , Hard	p.64
Saturation	Soft, <u>Standard</u> , Hard	
Tone Adjustment	Blue, <u>Black &amp; White</u> , Sepia	
Contrast	Soft, <u>Standard</u> , Hard	
Date Imprint	Date, Date & Time, Time, <u>Off</u>	p.64
IQ Enhancer	<u>On</u> , Off	p.64

## Movie Menu

Recorded Pixels	4K 30fps, <u>FullHD 30fps</u> , HD 60fps, HD 30fps	p.62
HDR	<u>On</u> , <u>Off</u>	
Microphone	<u>On</u> , <u>Off</u>	
Wind Suppression	<u>On</u> , <u>Off</u>	
Movie SR	<u>On</u> , <u>Off</u>	p.65
Movie SR+	<u>On</u> , <u>Off</u>	

## ▶ Playback Menu

Image Copy	[Internal M]>>>[Card], [Card]>>>[Internal M]	p.71
Protect	1 File, Sel. Multiple, Select All, Cancel All	p.72
Rotation	0°, 90° (counterclockwise), 180°, 90° (clockwise)	p.68
Slideshow	Interval: 30sec., 20sec., 10sec., 5sec., <u>3sec.</u> Screen Effect: <u>Wipe</u> , Checker, Fade, Random, Off Sound Effect: <u>On</u> , Off	p.67
Recover File	—	p.71
Resize	Recorded Pixels: L, M, S, XS, 2M, 1M, VGA Quality Level: ☆☆☆, ☆☆☆, ☆	p.74
Cropping	—	p.75
Filter	Small Face Filter: 5%, <u>7%</u> , 10% Ink Rubbing Filter: 1 to 5 Digital Filter: <u>B&amp;W/Sepia</u> , Toy Camera, Retro, Color, Extract Color, Color Emphasis, High Contrast, Starburst, Soft, Fish-eye, Miniature, Brightness HDR Filter	p.76
Movie Edit	Save as Still Image, Divide Movies, Adding title picture	p.77
Red-eye Edit	—	p.79
Start-up Screen	<u>Start-up screen with operation guide</u> , RICOH, Photographs, Off	p.84
Auto Image Rotation	<u>On</u> , <u>Off</u>	p.68

## C Customize Menu

Reg. USER	U1, U2	p.80
CALS Pixels	L, M, S, XS, 2M, <u>1M</u> , VGA	p.40
CALS Quality	☆☆☆☆, ☆☆☆, ☆☆☆	
ADJ Button Setting 1 ADJ Button Setting 2 ADJ Button Setting 3 ADJ Button Setting 4 ADJ Button Setting 5	Off, EV Comp. [Setting1], Recorded Pixels [Setting2], Aspect Ratio [Setting3], Setting [Setting4], White Balance [Setting5], Image Tone, Quality Level, AE Metering, AF, Face Detection, Highlight Cor., Shadow Cor., Outdoor View	p.82
Green Mode	<u>Green Mode</u> , EV Comp., Recorded Pixels, Quality Level, Aspect Ratio, White Balance, Setting, AF, Face Detection, Auto Macro, AE Metering, Highlight Cor., Shadow Cor., Sharpness, Saturation/Tone Adjustment, Contrast, Outdoor View	p.83
START DATE/TIME	<u>On</u> , Off	p.84
Show folder at startup	<u>On</u> , Off	
Shut-down Screen	<u>On</u> , Off	
Confirm. Time	<u>0.5sec.</u> , 1sec., 2sec., 3sec., HOLD, Off	
Quick Zoom	On, <u>Off</u>	p.39
Grid Guide Display Op.	<u>9 Divide</u> , 16 Divide	p.84
GPS	On, <u>Off</u>	p.89
GPS Disp Mode	<u>LAT/LON</u> , UTM, MGRS	
GPS Lock	On, <u>Off</u>	
GPS Time Adjustment	On, <u>Off</u>	p.90
GPS Log	Record log: Logging Interval, Logging Duration Save log data: NMEA, KML Discard log data	p.90
Compass Heading	<u>Off</u> , Cardinal, Degrees, Cardinal/Deg.	p.92
Compass Calibration	—	
Declination	<u>TRUE</u> , MAG	
Level Setting	Off, <u>Level + Shift</u> , Level	p.84
Calibrate Level	Reset Calibration	
Data Imprint	GPS Data Imprint: LAT/LON, UTM, MGRS, <u>Off</u> UTC Data Imprint: On, <u>Off</u> Heading Data Imprint: On, <u>Off</u>	p.93

Lens Adapter On	<u>Off</u> , WIDE	p.100
Movie Button	<u>On</u> , Off	p.45

Format [Card]	—	p.37
Format [Internal M]	—	
New folder options	<u>Standard</u> , Date, Custom	p.94
File name	<u>Standard</u> , Custom	p.96
File Sequence No.	<u>On</u> , <u>Off</u>	p.96
Reset File Number	—	p.97
Embed Info	<u>On</u> , <u>Off</u>	p.97
Copyright Info	A freely defined string of 32 characters	
Copyright Print	<u>On(OVR)</u> , <u>On(New)</u> , <u>Off</u>	p.98
Copyright Position	<u>Left</u> , <u>Middle</u> , <u>Right</u>	
Copyright Font Size	<u>Large</u> , <u>Middle</u> , <u>Small</u>	
Copyright Color	<u>Orange</u> , White, Black, Red, Blue, Green, Yellow	
Guide Display	<u>On</u> , <u>Off</u>	p.42
Cursor Pos. Keeping	<u>On</u> , <u>Off</u>	p.23
LCD Brightness	-4 to +4	p.85
Power Saving	<u>Off</u> , <u>5sec.</u> , 15sec., 30sec., 1min., 2min.	p.86
Outdoor View	-2 to +2	p.85
Power Button Lamp	<u>On</u> , <u>Off</u>	p.85
Operation Volume	<u>Off</u> , 1 to 5 [3]	p.85
Playback Volume	<u>Off</u> , 1 to 8 [3]	
Sound	Startup Sound, Shutter Sound, Operation Sound, Self-timer Sound	
Auto Power Off	<u>1min.</u> , 3min., 5min., 10min., 30min., <u>Off</u>	p.86
Monitor Auto off Delay	<u>Off</u> , 1min., 5min., 30min.	p.86
Power Button Hold Op.	<u>On</u> , <u>Off</u>	p.35
Certifications	—	—
Version Info	—	—
Camera Settings File	<u>Write</u> , Read	p.81
USB Connection	<u>MSC</u> , MTP, UVC	p.47, p.73
HDMI Out	<u>AUTO</u> , 2160P (4K), 1080i, 720P, 480P	p.69
FlashAir Connection	<u>On</u> , <u>Off</u>	p.32

Language/言語	English, French, German, Spanish, Portuguese, Italian, Dutch, Danish, Swedish, Finnish, Polish, Czech, Hungarian, Turkish, Greek, Russian, Thai, Korean, Traditional Chinese, Simplified Chinese, Japanese	p.36
Date Adjustment	Date Format: Y/M/D, D/M/Y, M/D/Y Date: January 1, 2024 to December 31, 2045 Time: 00:00 to 23:59	p.36
World Time	Select Time: <u>Hometown</u> , Destination Hometown: City, DST Destination: City, DST	p.99
Initialized Setting	Still, Movie, Playback, Customize, Setup, Quality	p.23
Reset	—	



## Setting the Battery and a Memory Card

### Inserting the Battery and a Memory Card

2

Getting Started

SD memory cards, SDHC memory cards, and SDXC memory cards can be used with this camera. "Memory card" refers to these memory cards in this manual.

**1** Make sure that the camera power is off.

**2** Slide the release lever on the bottom of the camera toward OPEN, and slide the battery/card cover to the right to open it.



**3** Make sure that the memory card is facing the right way and then push the card all the way in until it clicks.

To remove it, press in the memory card and then release your hand.

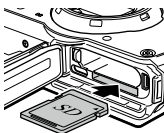

**4** Insert the battery.

Use the rechargeable battery (DB-110) to press the latch and insert the battery all the way into the battery compartment.

To remove the battery, slide the latch.

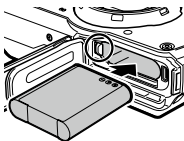

**5** Close the battery/card cover and slide it to the left.

Slide the battery/card cover until it clicks and confirm that it is closed securely.

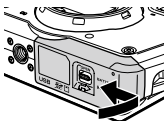

**Caution** -----

- When opening and closing the battery/card cover, be sure to remove water and dirt such as sand adhering to the camera, and avoid locations where dirt can enter the camera interior.
- Close the battery/card cover securely. If the battery/card cover is not closed securely, water or dust may enter the camera interior.

**Data Storage Location**

Images taken and movies recorded with this camera are saved in the internal memory or a memory card.

**Memo** -----

- Saved images can be copied between the internal memory and the memory card. (p.71)
- The storage capacity varies depending on the memory card. (p.112)

**FlashAir Card** -----

- An SD memory card with a built-in wireless LAN function (FlashAir card) can be used with the camera. When communicating using the FlashAir card, set [FlashAir Connection] to [On] in the  menu. If the write-protect switch of the FlashAir card is locked, the settings cannot be made.
- Use of an access point and an Internet connection are required for transferring images via a wireless LAN. For details, refer to the card manufacturer's website, etc.
- The operability of FlashAir card functions including the wireless transmission function is not guaranteed with this camera. Contact the FlashAir card manufacturer regarding any malfunctions or problems concerning FlashAir cards. FlashAir cards can be used only in the country in which the card was purchased. For details, contact the FlashAir card manufacturer.

## Charging the Battery

Charge the rechargeable battery DB-110 using the provided USB cable, USB power adapter, and power plug before use.

- 1** Insert the power plug to the USB power adapter.

Insert it until it clicks into place.

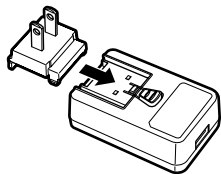

- 2** Open the battery/card cover, and connect the USB cable to the USB terminal.

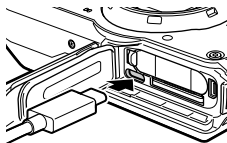

- 3** Connect the USB cable to the USB power adapter.

- 4** Plug the USB power adapter into a power outlet.

The power button lamp of the camera turns on and charging starts.

Depending on the battery level, the charging time differs. An exhausted battery will be fully recharged in about 3 hours (at 25°C (77°F)).

When charging is complete, the power button lamp turns off.

- 5** Remove the USB cable from the USB terminal, and close the battery/card cover.

- 6** Unplug the USB power adapter from the power outlet.

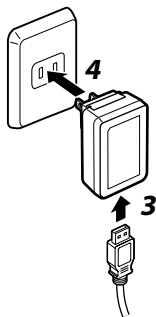

**Storage Capacity**-----

- About 340 pictures can be taken when the battery is fully charged.
- This is based on tests conducted according to CIPA standards under the following conditions: At 23°C (73°F) temperature; the monitor is on; a picture is taken every 30 seconds; the flash is fired every two pictures; the camera is turned off and back on after 10 pictures are taken.
- The storage capacity is for reference. For long periods of use, it is recommended that you carry spare batteries.

**Caution**-----

- When opening and closing the battery/card cover, be sure to remove water and dirt such as sand adhering to the camera, and avoid locations where dirt can enter the camera interior.
- Use only genuine rechargeable battery (DB-110).
- If the battery starts to run down more quickly even after being charged, the battery has reached the end of its service life. In this case, replace the battery with a new one.
- The battery may become very hot immediately after operation. Turn the camera off and leave it to cool down sufficiently before removing the battery.

**Memo**-----

- You can also charge the battery by connecting the camera to a computer using the USB cable. (p.73)
- The battery can be recharged with the optional battery charger BJ-11.

## Initial Settings

Turn the camera on and make the initial settings.

### Turning the Camera On

#### 1 Press the power button.



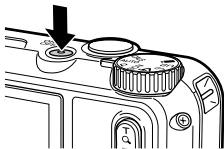

The power button lamp turns on.

The first time the camera is turned on after purchase, the [Language/言語] screen appears.

When the power button is pressed again, the power turns off.



#### Memo

- When  is pressed and held with the camera turned off, the camera turns on in the playback mode. The following operations are available.
- The power button lamp can be set to [Off] in [Power Button Lamp] of the  menu. (p.85)
- If no operations are made for about one minute (default setting), the camera turns off automatically to suppress battery drain. The power saving function can be set in the  menu. (p.86)
- The display of the start-up screen can be set in [Start-up Screen] of the  menu. (p.84)
- You can also make settings so that the camera is turned on and off by pressing and holding the power button to prevent misoperation. When [Power Button Hold Op.] is set to [On] in the  menu, press and hold the power button for about 2 seconds to turn the camera on, and press and hold for about 5 seconds to turn the camera off.

## Setting the Language and the Date and Time

You can set the display language for menus and the date and time.

**1** Use ▲▼ to select a language and press **OK**.

The selected language is set and the [Date Adjustment] screen appears.

**2** Set the display format and the date and time.

Use ◀▶ to select an item and ▲▼ to change the value.

Press **MENU** to cancel the setting.

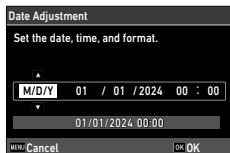

**3** Press **OK**.

The date and time are set and the camera is ready to take a picture.



### Memo

- If the battery is removed for about five days, the date and time settings will be lost. To retain the date and time settings, insert a battery with sufficient power for at least two hours, and then remove the battery.
- You can change the language and the date and time settings in the  menu.

## Formatting a Memory Card

When using a new memory card or a memory card used with another device, be sure to format the memory card with this camera. The internal memory can also be formatted with the same operations.

**1** Press **MENU**.

The menu appears.

**2** Press **◀**, and use **▲▼** to select **↷**.

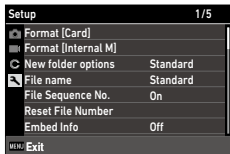

**3** Press **▶**, select **[Format [Card]]**, and press **▶**.

When formatting the internal memory, select **[Format [Internal M]]**.

**4** Use **▲** to select **[Execute]**, and press **OK**.

The memory is formatted.

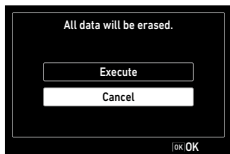

**5** Press **OK**.

**6** Press **MENU**.

The shooting screen reappears.

**⚠ Caution** -----

- Do not remove the memory card while formatting, or the card may be damaged.
- Formatting deletes all data, both protected and unprotected.
- Do not format FlashAir cards with this camera.

# Basic Shooting Operation

## Shooting in the Auto Mode

The camera automatically selects the optimal capture mode.

2

Getting Started

### 1 Set the mode dial to **AUTO**.

The capture mode is set to **AUTO**, and the Live View is displayed.

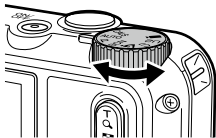

### 2 Use (T)/ (W) to change the zoom magnification.

The optical zoom up to 5x magnification is available. The digital zoom up to 40.5x magnification is available by further pressing .

### 3 Press **SHUTTER** halfway.

The capture mode is selected, and the focus is adjusted.

When the subject cannot be in focus, the red frame appears.

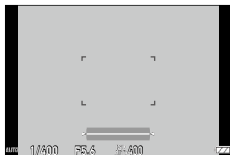

### 4 Press **SHUTTER** fully.

The image you have just taken is displayed on the monitor (Instant Review) and saved.



#### **Instant Review and Blink Detection**

- You can set the display time of Instant Review in [Confirm. Time] of the **C** menu. When set to [Hold], the Instant Review is displayed until **SHUTTER** is pressed halfway or the mode dial is turned.
- If the camera detects that the subject's eyes are closed, the message [Closed eyes have been detected] appears during Instant Review. You can also set [Blink Detection] to [Off] in the **Q** menu to disable this function.



**Zoom**

- When is pressed and held, the zooming method switches from the optical zoom to the intelligent zoom. If is release and pressed again, the zooming method switches from the intelligent zoom to the digital zoom with up to 40.5x magnification. The digital zoom magnification varies depending on the [Recorded Pixels] settings in the menu.
- The quality of images captured with the digital zoom slightly deteriorates. You can set whether to use the digital zoom in [Digital Zoom] of the menu.

**Viewing the Captured Images**

Review the captured image on the monitor.

**1**

Press .

The camera switches to the playback mode and the last image you took is displayed. (Single image display)

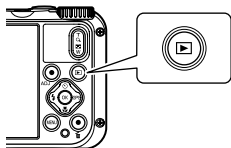
**2**

View an image.

The following operations are available.

	Displays the previous or next image.
Press and hold	Fast-reverses/Fast-forwards playback.
	Reverses/Forwards playback by 10 frames.
	Deletes the image.
(T)	Magnifies the image.
(W)	In magnified view: Reduces the image.
	In magnified view: Moves the magnified area.
	Switches the displayed information.







**Memo**

- Movies cannot be magnified.
- When [Quick Zoom] is set to [On] in the menu, pressing once magnifies the image at the maximum magnification.

## Taking Still Images



### Setting the Capture Mode

Turn the mode dial to select capture modes.

 <b>CALS</b> CALS Mode	Takes images with the recorded pixels and quality level set in [CALS Pixels] and [CALS Quality] of the <b>C</b> menu. The aspect ratio is fixed to [4:3]. By default, the recorded pixels are set to [1M] and the quality level is set to [☆☆☆]. These settings are appropriate to take construction site pictures submitted to local authorities.
 <b>AUTO</b> Auto Mode	Takes images with the optimal capture mode automatically selected by the camera. (p.38)
 <b>P</b> Program Mode	Takes images with the shutter speed and aperture value automatically set by the camera.
 <b>SCN</b> Scene Mode	Selects a scene from various scenes and takes images with the optimal settings for the selected scene. (p.41)
 <b>Digital Microscope Mode</b>	Turns the ring light on for shooting at a close focus distance of 1 cm to the subject. The focus mode, flash mode, recorded pixels, and aspect ratio are fixed to [1cm Macro], [Ring Light], [XS], and [4:3], respectively. You can fix the distance to the subject to 1 cm by attaching the provided macro stand (p.11) to the camera.
 <b>U1/U2</b> User Mode	Uses the saved shooting settings. (p.80)
 <b>Movie Mode</b>	Records a movie. (p.44)



#### Green Mode

- When the green button is pressed, the camera switches to the green mode. In this mode, you can perform shooting with the standard settings regardless of the capture mode and  menu settings. Press the green button again to return to the previous capture mode.
- In the green mode, the  menu settings cannot be changed.
- If the camera is turned off in the green mode, the camera turns on in the green mode next time.
- The green mode cannot be used when [Green Mode] is set to a function other than the green button in the **C** menu.

## Performing Shooting in the Scene Mode

- 1** Set the mode dial to **SCN**.  
The mode switches to the **SCN** mode.
- 2** Press **MENU**.  
The **SCN** menu appears.
- 3** Use **▲▼◀▶** to select a scene.

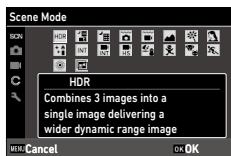

The following scenes can be selected.

- |   |   |
|---|---|
|  HDR                 |  Interval Shooting |
|  Handheld Night Snap |  Interval Movie    |
|  Night Scene         |  High Speed Movie  |
|  Underwater          |  Surf & Snow       |
|  Underwater Movie    |  Kids              |
|  Landscape           |  Pet               |
|  Flower              |  Sport             |
|  Portrait           |  Fireworks        |
|  Digital SR        |  DOF Composite   |

- 4** Press **OK**.  
The scene is set.



**Memo** -----

- The **SCN** menu is displayed only in the **SCN** mode.
- When the scene is set to [Interval Shooting] or [Interval Movie], shooting is performed at a fixed interval. You can set [Interval], [Number of Shots] ([Total Time] for [Interval Movie]), and [Start Delay].
- A description of the selected scene is displayed on the screen in Step 3. If you do not want to display this description, set [Guide Display] to [Off] in the  menu.



**Caution** -----

- The functions that can be set vary depending on the scene.
- When shooting with [HDR] or [DOF Composite], secure the camera on a tripod or similar device.
- [Interval Shooting] and [Interval Movie] cannot be selected during the GPS logging. (p.90)

## Using Exposure Compensation

- 1** Select [EV Comp.] in the  menu, and press .

The [EV Comp.] screen appears.

- 2** Use   to select a compensation value.

The compensation value can be selected in the range of  $\pm 2.0$ .

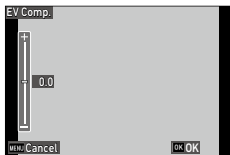

- 3** Press .

- 4** Press .

The shooting screen reappears.



**Caution** -----

- The exposure compensation is not available in the **AUTO** mode.

## Recording Movies

Movies can be directly recorded even when the mode dial is set to a mode other than **1**.

### 1 Set [Movie Button] to [On] in the **C** menu.

Movie recording with the movie button is enabled.

### 2 Press the movie button.

Recording starts.

The recording time is displayed while recording.

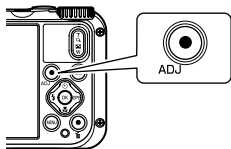

### 3 Press the movie button again.

Recording stops.



#### Memo

- Regardless of the mode dial setting, when the movie recording has been started with the movie button, [Recorded Pixels] and [Movie SR] are fixed to [FullHD 30fps] and [On], respectively.
- When the mode dial is set to **1**, use **SHUTTER** to start the movie recording.



## Caution

---

- When [Movie Button] is set to [Off] in the **C** menu, turn the mode dial to **M** and use **SHUTTER** to start and end the movie recording.
- When the movie recording has been started with the movie button, use the movie button to end the recording.
- The movie recording cannot be started with the movie button in the following cases.
  - In [Underwater Movie], [Interval Shooting], [Interval Movie], [High Speed Movie], or [Pet] of the **SCN** mode or in the **S** mode
  - When [Face Detection] is set to [Smile] or [Assist+Smile] in the **Q** menu
- When [Microphone] is set to [On] (default setting) in the **M** menu, camera operation sounds are also recorded.
- If the internal temperature of the camera becomes high during recording, recording may be terminated.
- The flash cannot be used in the **M** mode.
- When the function of the movie button has been changed in [ADJ Button Setting 1] to [ADJ Button Setting 5] of the **C** menu, use **SHUTTER** to start recording. (p.82)
- You can record a movie continuously up to 4 GB or 25 minutes. Recording stops when the memory card or internal memory becomes full. The maximum recording time per shooting depends on the capacity of the memory card. (p.112) Shooting may stop even before the maximum recording time is reached.
- The amount of time remaining is calculated based on the amount of memory available and may not diminish at an even rate.
- For the memory cards with which proper operation has been confirmed for recording movies, refer to p.113.
- The use of the battery with sufficient power or the optional AC adapter (K-AC166) is recommended.

## Playing Back Movies

### 1 Press .







An image is displayed in the single image display of playback mode.

### 2 Use to select a movie to play back.

The first frame of the movie is displayed as a still image.



### 3 Play back a movie.

The following operations are available.

	Plays back/Pauses a movie.
	Fast-reverses/Fast-forwards playback.
	Stops playback.
 (T) /  (W)	Adjusts the sound volume.
	Switches the displayed information.



#### Memo

- The sound volume at the start of movie playback can be set in [Playback Volume] of the  menu.
- In [Movie Edit] of the  menu, you can divide a movie file into multiple segments and add a title image to a movie. (p.77)



## Using the Camera as a Webcam

You can use the camera as a webcam when conducting video conferences, etc. via the network.

The camera is compatible with the following web conferencing software.



- Zoom
- Skype
- Microsoft Teams
- Google Meet
- Cisco Webex
- Facebook Messenger



### Caution

- The webcam function is compatible with the following OS.
  - Windows® 11, Windows® 10
  - macOS 14 Sonoma, macOS 13 Ventura, macOS 12 Monterey, macOS 11 Big Sur

## Installing the Camera

- 1 Select [USB Connection] in the  menu, and press .
- 2 Select [UVC], and press .
- 3 Open the battery/card cover of the camera, and connect the USB cable to the USB terminal.  
The AF assist light turns on and the camera enters the UVC mode.
- 4 Fix the camera on a tripod or similar device.
- 5 Start the web conferencing software and select "PENTAX WG-8" in the camera settings of the software.
- 6 To exit the UVC mode, turn the camera off.

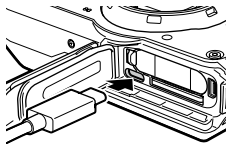

**Caution**

- The image quality in the UVC mode is fixed to [FullHD 30fps].
- During the UVC mode, nothing is displayed on the camera monitor.
- During the UVC mode, the microphone of the camera cannot be used.
- When mounting the camera on a tripod or similar device, use the optional Extension Adapter TE-2.

**Memo**

- For the software settings, refer to the help, etc. of each software.
- You can change the angle of view by operating (T)/ (W) during the UVC mode.
- Even in the UVC mode, autofocus operates within the normal range (10 cm to ∞). If you want autofocus to operate at a closer distance, press (▼) to switch to [1cm Macro].
- The UVC mode is retained even when the camera is turned off. To cancel the UVC mode, remove the USB cable and set [USB Connection] to a mode other than [UVC] in the menu.

**Using the Ring Light Together**

- When the mode dial is set to **U1** during the UVC mode, the ring light turns on. To turn off the ring light, set the mode dial to a mode other than **U1**.
- The brightness and lighting position of the ring light can be changed in [Ring Light] of the menu. During the UVC mode, the ring light remains on regardless of the [LightningTime] setting.
- When the ring light is used, the continuous usage time of the webcam function is limited. The estimated continuous usage time when the battery is fully charged is as follows.

[Ring Light] Setting	Continuous Usage Time
Off	Approx. 360 minutes
Brightness [1]	Approx. 200 minutes
Brightness [5]	Approx. 45 minutes
Brightness [9]	Approx. 20 minutes

The continuous usage time varies depending on the room temperature, etc.

- If the ring light is turned on for a long period of time, the camera becomes hot and is forced to be turned off. In this case, handle the camera carefully. The camera is unavailable for use for a while until it cools down.





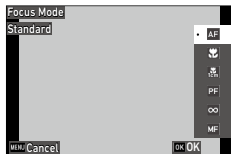

## Setting the Focus Mode

**1** Press  (▼) in the shooting mode.

The [Focus Mode] screen appears.

**2** Use ▲▼ to select a setting.



 Standard	Focuses on the subject at a distance of 50 cm or more from the camera when <b>SHUTTER</b> is pressed halfway. When [Auto Macro] is set to [On] (default setting) in the  menu, focusing is also performed for subjects in the macro range.
 Macro	Focuses on the subject at a distance of 10 to 60 cm from the camera.
 1cm Macro	Focuses on the subject at a distance of 1 to 30 cm from the camera.
 Pan Focus	Focuses on the entire picture, from the front to the back.
 Infinity	Fixes the focus distance at infinity. This is useful for shooting distant scenes.
 MF	Focuses manually. (p.51)

**3** Press **OK**.

The shooting screen reappears.



## Memo

- The focus mode can also be set in [Focus] of the menu.
- The autofocus method for the still image mode can be set in [AF] of the menu.

Multi	Measures the distances from 3 × 3 AF areas and focuses to the nearest AF area. (Default setting)
Spot	Focuses to the center AF area.
Tracking	Keeps focusing while <b>SHUTTER</b> is pressed halfway

- Faces of people (up to 30 people) are automatically detected during autofocusing. The detection method can be selected in [Face Detection] of the menu.

On	Detects human faces.
Smile	Automatically performs shooting when the subject smiles.
Assist	Flashes the ring light when a human face is detected. The position of flashing ring light LED indicates where the face is detected within the angle of view.
Assist+Smile	Flashes the ring light when a human face is detected and automatically performs shooting when the subject smiles.
Off	Does not detect human faces.

- The AF assist light on the front of the camera lights as necessary during autofocusing. The AF assist light can be set to [Off] in [Focus Assist] of the menu.

## Focusing Manually (Manual Focus)

If the camera fails to focus automatically, you can focus manually. The manual focus enables shooting at a fixed distance.

**1** Select [MF] in Step 2 on p.49, and press **OK**.  
The focus bar appears on the shooting screen.

**2** Use **▲▼** to set a focus distance.

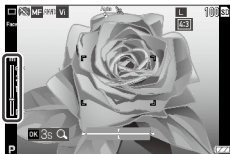

When **OK** is pressed and held, the center of the screen is magnified. Pressing and holding **OK** again restores the normal display.

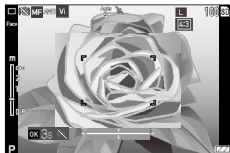



### Memo

- When changing the focus mode from [MF], change the mode in [Focus] of the menu.



## Setting the Exposure



### Selecting a Metering Method

Set the metering method in [AE Metering] of the  menu.

 Divide	Meters exposure in multiple areas of the frame.
 Center	Meters exposure with emphasis on the center.
 Spot	Meters exposure within a narrow range. Use this option when metering exposure in a part of an image or when the metering target subject is small.

## Setting the ISO Sensitivity

**1** Select [ISO Setting] in the  menu, and press .

**2** Use   to select a setting.

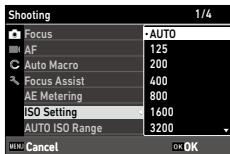

**3** Press .

**4** Press .

The shooting screen reappears.



### Memo

- The settings that can be selected vary depending on the capture mode. When the following scenes are selected in the **SCN** mode, settings cannot be made for [ISO Setting].
  - [Digital SR], [Interval Movie], [High Speed Movie]
  - [HDR] (The setting is fixed to [AUTO].)
- When [ISO Setting] is set to [AUTO] or when [HDR] is selected in the **SCN** mode, the adjustment range of [AUTO] can be set in [AUTO ISO Range] of the  menu. [AUTO ISO Range] cannot be set in the **CALS** mode.







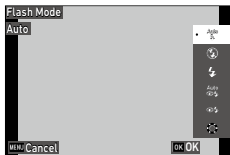

### Caution

- Images taken with a higher sensitivity may appear grainy.
- Depending on the ISO sensitivity setting, the setting of [D-Range Setting] of the  menu is disabled. (p.65)

## Using the Flash

- 1 Press **⚡** (◀) in the shooting mode.  
The [Flash Mode] screen appears.
- 2 Use ▲▼ to select a setting.



 Auto	Fires the flash according to conditions.
 Flash Off	Does not fire the flash.
 Flash On	Always fires the flash.
 Auto+R. eye	Fires the flash according to conditions while reducing the red-eye phenomenon.
 On+Red-eye	Forces the flash to fire while reducing the red-eye phenomenon.
 Ring Light	Turns on the ring light around the lens. (p.55)

- 3 Press **OK**.  
The shooting screen reappears.





### Memo

- The flash mode can also be set in [Flash Mode] of the menu.
- When [Underwater] is selected in the **SCN** mode, both an image with the flash used and an image with the flash not used can be taken.



### Caution

- You cannot perform shooting while the flash is being charged.
- The flash cannot be used in the mode.

## Using the Ring Light

Select [Ring Light] in Step 2 on p.54 and press to set the brightness of the ring light. The settings for the ring light can be made in [Ring Light] in the menu.

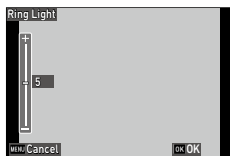

Select	[All], [Right], [Left], [High], [Low], [Off]
Brightness	[1] to [9]
LightningTime	[Always On], [Shutter 10s], [Shutter 20s], [Shutter 30s], [Shutter 60s]







### Caution







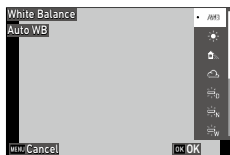

- [Ring Light] cannot be selected in the following cases.
  - In the **AUTO** mode, **SCN** mode, or mode



## Setting the White Balance

Make adjustments to the white balance so that white subjects will appear white under any kind of light.

- 1 Select [White Balance] of the  menu, and press  .  
The [White Balance] screen appears.
- 2 Use   to select a setting.



 Auto WB	Adjusts the white balance automatically.
 Daylight	Used when shooting in daylight under clear skies.
 Shade	Used when shooting in shade.
 Cloudy	Used when shooting in daylight under cloudy skies.
 Fl. DL Color	Used with daylight fluorescent lighting.
 Fl. DL White	Used with neutral white fluorescent lighting.
 Fl. Cool Wt.	Used with cool white fluorescent lighting.
 Fl. Warm Wt.	Used with warm white fluorescent lighting.

 Tungsten	Used with incandescent lighting.
 Ring Light	Used when the ring light of the camera is used.
 Manual WB	Set the white balance manually. (p.57)

**3** Press **OK**.

**4** Press **MENU**.

The shooting screen reappears.



**Caution** -----

- The white balance may not be adjusted correctly for a subject that is mostly dark.

## Setting the White Balance Manually

**1** Select [Manual WB] in Step 2 on p.56.

**2** Aim the camera at a white subject, such as a sheet of paper, under the light for shooting.

**3** Press the green button.

An image to be used for white balance adjustment is taken.

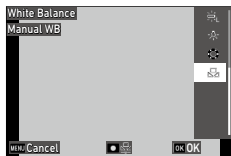



**4** Press **OK**.

**5** Press **MENU**.

The shooting screen reappears.

## Setting the Drive Mode

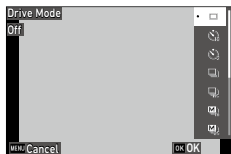

You can set the drive mode by pressing  (▲) in the shooting mode. The drive mode can also be set in [Drive Mode] of the  menu.



## Shooting Using the Self-timer

**1** Press  (▲) in the shooting mode. The [Drive Mode] screen appears.

**2** Use ▲▼ to select a setting.

 Self-Timer 10s	Releases the shutter about 10 seconds after <b>SHUTTER</b> is pressed.
 Self-Timer 2s	Releases the shutter about 2 seconds after <b>SHUTTER</b> is pressed.

**3** Press **OK**.  
The shooting screen reappears.





**4** Press **SHUTTER**.  
The AF assist light blinks during the countdown, and the shutter is released after about 10 seconds or 2 seconds.  
When **SHUTTER** is pressed halfway during the countdown, the self-timer is canceled.

## Shooting Continuously

**1** Press  (▲) in the shooting mode.

The [Drive Mode] screen appears.

**2** Use ▲▼ to select a setting.



 Cont. Shoot	Performs continuous shooting while <b>SHUTTER</b> is pressed.
 Burst Shoot	Fixes the recorded pixels and aspect ratio to [S] and [4:3], respectively, and performs continuous shooting at high speed.
 M-Cont	Performs continuous shooting while <b>SHUTTER</b> is pressed, and saves last 16 or 25 still images taken for 2 seconds before the button is released as an image of 5184 × 3888 pixels. (Memory retrospective continuous shooting)
 S-Cont	Performs continuous shooting for 16 or 25 still images after <b>SHUTTER</b> is fully pressed, and saves them as an image of 5184 × 3888 pixels. (Streaming continuous shooting)

**3** Press **OK**.

The shooting screen reappears.



### Caution

- The following functions cannot be used.
  - Flash
  - [On(New)] for [Copyright Print] in the  menu
- [Cont. Shoot] cannot be selected in the following capture modes.
  - **AUTO** mode
  - [Night Scene], [Underwater Movie], [Interval Shooting], or [Fireworks] in the **SCN** mode
  -  mode

**Memo** -----

- The focus setting and exposure value are fixed during continuous shooting.
- The maximum number of images that can be taken continuously varies depending on the [Recorded Pixels] setting in the menu.
- The continuous shooting setting is reset when the camera is turned off and on again.
- If you release **SHUTTER** early for [M-Cont], the number of saved images may not reach 16 or 25.
- The images taken with [M-Cont] or [S-Cont] are displayed in 16 or 25 thumbnails in the single image display of mode. Press (T) to display an image in the single image display, and to display the previous or next image.



**Shooting Using the Remote Control Unit**

You can perform shooting using the optional remote control unit.

**1** Press (▲) in the shooting mode.

The [Drive Mode] screen appears.

**2** Use ▲▼ to select a setting.

 0-sec Remote Control	Releases the shutter immediately after the shutter release button on the remote control unit is pressed.
 3-sec Remote Control	Releases the shutter about 3 seconds after the shutter release button on the remote control unit is pressed.

**3** Press **OK**.





The shooting screen reappears.

**4** Point the remote control unit towards the remote control receiver of the camera, and press the shutter release button.**Memo** -----

- The maximum operating distance of the remote control unit is about 4 m from the front of the camera and about 2 m from the rear of the camera.

## Shooting with Varied Exposure Values

Takes three images with different exposure settings of -1.0 EV, 0 EV, and +1.0 EV.

- 1** Press  (▲) in the shooting mode.  
The [Drive Mode] screen appears.
  - 2** Use ▲▼ to select [A-Bracket], and press .
  - 3** Press .
- Three images are taken by pressing  once.  
The three images are displayed side by side during Instant Review.

## Configuring the Capture Settings

### Image Capture Settings

Set the file format for still images in the  menu.

Recorded Pixels	[L], [M], [S], [XS], [VGA]
Aspect Ratio	[4:3], [3:2], [1:1]
Quality Level	[☆☆☆☆], [☆☆☆], [☆☆]

3

Shooting



#### Caution

- The settings that can be selected are limited depending on the capture mode.



#### Memo

- The capture settings for the **CALS** mode can be made in [CALS Pixels] and [CALS Quality] of the  menu.

### Movie Capture Settings

Set the file format for movies in the  menu.

Recorded Pixels	Sets the number of recorded pixels. [4K 30fps] (3840 × 2160) [FullHD 30fps] (1920 × 1080) [HD 60fps] (1280 × 720) [HD 30fps] (1280 × 720)
HDR	Sets whether to perform the HDR recording.
Microphone	Sets whether to record sounds.
Wind Suppression	Reduces wind noise during recording.





#### Memo

- For the reduction of blurring during recording movies, refer to “Reducing Blurring of Images” (p.65).



#### Caution

- When [Recorded Pixels] is set to [4K 30fps] or [HD 60fps], [Movie SR+] of the  menu and [HDR] are fixed to [Off].
- [Movie SR+] of the  menu and [HDR] cannot be set simultaneously.









# Setting the Image Finishing Tone and Correction

## Setting the Image Atmosphere (Image Tone)

You can control the finishing tone for taken images.

**1** Select [Image Tone] in the  menu, and press **▶**.  
The [Image Tone] screen appears.

**2** Use **▲▼** to select a setting.

 Bright	Increases the values of [Contrast], [Sharpness], and [Saturation] to take sharp images.
 Natural	Takes images with a natural tone close to the actual color.
 Vibrant	Takes bright and gorgeous images with a deep tone of color.
 Slide Film	Takes contrast-emphasized images like those taken with a reversal film.
 Monochrome	Takes a black and white image. Set [Tone Adjustment] in the  menu. (p.64)



**3** Press **OK**.

**4** Press **MENU**.

The shooting screen reappears.

## Setting the Sharpness, Saturation, Tone, and Contrast

The following settings can be made in the  menu.



Sharpness	[Soft], [Standard], or [Hard] can be selected.
Saturation	[Soft], [Standard], or [Hard] can be selected. [Saturation] can be set only when [Image Tone] is set to [Monochrome] in the  menu.
Tone Adjustment	[Blue], [Black & White], or [Sepia] can be selected. [Tone Adjustment] can be set only when [Image Tone] is set to [Monochrome] in the  menu.
Contrast	[Soft], [Standard], or [Hard] can be selected.

## Imprinting the Date on Still Images

The date can be imprinted at the bottom right of the image based on the date set in the camera. The date imprinting can be set in [Date Imprint] of the  menu.



### Caution

- The imprinted date cannot be deleted.
- The date cannot be imprinted in the following cases.
  - During the shooting in [Underwater Movie] or [High Speed Movie] of the **SCN** mode.
  - In the  mode
  - When [Drive Mode] is set to [Burst Shoot], [M-Cont], or [S-Cont]
- When [UTC Data Imprint] of [Data Imprint] is set to [On] in the **C** menu, [Date Imprint] is fixed to [Off] in the  menu. (p.93)

## Taking Images with Clearer Details

Images with clearer details can be taken by image processing. Set in [IQ Enhancer] of the  menu.



### Caution

- [IQ Enhancer] is disabled in the following case.
  - When [Drive Mode] is set to [Burst Shoot], [M-Cont], [S-Cont], or [A-Bracket]

## Correcting a Range of Tones (D-Range Setting)

With [D-Range Setting] of the  menu, you can expand an image gradation to make the bright and dark portions of an image clearly visible.

Highlight Cor.	Corrects the bright portions of the image.
Shadow Cor.	Corrects the dark portions of the image.



### Caution

- When the shooting location is too bright or too dark, the [D-Range Setting] setting may not be effective.

## Reducing Blurring of Images

To automatically reduce blurring of images, set the following functions.

Still image mode	[Pix. Track SR] in the  menu
Movie mode	[Movie SR] or [Movie SR+] in the  menu



### Memo

- Setting [Movie SR+] to [On] achieves movies with less blurring.



### Caution

- [Movie SR] and [Movie SR+] are fixed to [Off] in the following case.
  - When [Interval Movie] or [High Speed Movie] is selected in the **SCN** mode
- [Movie SR+] is fixed to [Off] in the following cases.
  - When [Recorded Pixels] is set to [4K 30fps] or [HD 60fps]
  - When [HDR] is set to [On] in the  menu

## Changing the Playback Method

### Displaying Multiple Images

You can display multiple images in the thumbnail view.

- 1 Press **W** (W) in the single image display of playback mode.  
The images are displayed in 20 thumbnails.

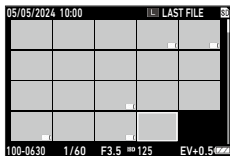

The following operations are available.

	Moves the selection frame.
	Switches between the 20-thumbnail display, the 81-thumbnail display, and the folder (calendar) display.
Green button	Switches between the folder display and the calendar display.
	Deletes the selected image. (p.70)

- 2 Press **OK**.  
The selected image is displayed in the single image display.



**Memo** -----

- Images are played back in the order of file numbers automatically assigned to them.

## Playing Back Images Continuously (Slideshow)

- 1** Select [Slideshow] in the **▶** menu, and press **▶**.

The [Slideshow] screen appears.

- 2** Set the image switching interval and screen effects.

Interval	Sets the image switching interval. [Interval] cannot be set when [Screen Effect] is set to [Random].
Screen Effect	Sets the screen effects applied when images are switched.
Sound Effect	Sets the sound effects. [Sound Effect] is fixed to [Off] when [Screen Effect] is set to [Random].

- 3** Select [Start], and press **OK**.



A slideshow starts.

When **OK** is pressed, the slideshow pauses or resumes.

When any other button is pressed, the slideshow stops.

## Displaying Rotated Images

You can change image rotation information.

- 1 Display an image in the single image display of playback mode.
- 2 Select [Rotation] in the  menu, and press .
- 3 Select the rotation direction, and press **OK**.

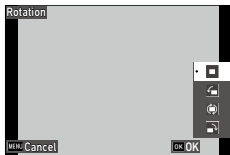

4

Playback Functions



### Caution

- Rotation direction cannot be changed when the write-protect switch on the memory card is locked or for the following images.
  - Movies
  - Images taken with [M-Cont] or [S-Cont]
  - Protected images



### Auto Image Rotation

- When [Auto Image Rotation] is set to [On] in the  menu, the displayed image is rotated according to the camera's orientation during the single image display. When [Auto Image Rotation] is set to [Off] (default setting), the image display orientation is fixed regardless of the [Rotation] setting.
- Movies cannot be rotated.
- Images are not rotated in the following cases.
  - During a slideshow
  - While an AV device is connected to the camera

## Connecting the Camera to an AV Device

Connect to an AV device, such as TVs, equipped with an HDMI® terminal to display Live View images while shooting or to play back images. Prepare a commercially available HDMI® cable that is suitable for the device connected to the camera.

- 1 Turn the AV device and camera off.
- 2 Open the battery/card cover of the camera, and connect the HDMI® cable to the HDMI® micro output terminal.

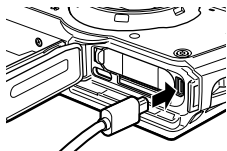

- 3 Connect the other end of the HDMI® cable to the input terminal on the AV device.

For details, refer to the operating manual for the AV device.

- 4 Turn the AV device and camera on.



### Caution

- When opening and closing the battery/card cover, be sure to remove water and dirt such as sand adhering to the camera, and avoid locations where dirt can enter the camera interior.
- While the camera is connected to an AV device, nothing is displayed on the camera monitor.
- The audio of the movie is output from the AV device. Adjust the volume on the AV device.
- Use an HDMI® cable with a length of 3 m or less (recommended product: CAC-HD14EU15BK manufactured by ELECOM). The RICOH HDMI cable HC-1 cannot be used.





### Memo

- If the camera is connected to an AV device in the playback mode, an image is displayed in the single image display.
- When outputting images to an AV device with an HDMI® terminal, the maximum resolution supported by both the AV device and camera is automatically selected. If the AV device fails to play back images properly, change the setting in [HDMI Out] of the  menu.

# Organizing Files

## Deleting Files

- 1 Press  in the single image display or multiple image display.
- 2 Select the deletion method, and press **OK**.

Available deletion methods vary depending on the camera status when  is pressed.

Single image display	[Delete One], [Delete Multi], or [Delete All] can be selected. When [Delete Multi] is selected, select [Sel. Individ.] or [Sel. Range].
20-thumbnail display or 81-thumbnail display	[Sel. Individ.] or [Sel. Range] can be selected.

When [Delete All] is selected, proceed to Step 5.

- 3 Select the images to delete.

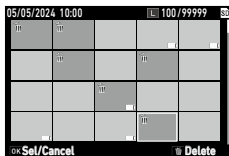

	Moves the selection frame.
<b>OK</b>	Selects/Deselects an image. When [Sel. Range] is selected: Selects the starting or ending point for image selection range.

- 4 Press .  
The confirmation screen appears.
- 5 Select [Execute], and press **OK**.  
The selected images are deleted.



### Memo

- Protected images cannot be selected.





## Restoring Deleted Files

You can restore the deleted files in [Recover File] of the  menu.





### Caution

- The images cannot be restored when the following operations have been performed after deleting them.
  - Turning the camera off
  - Switching from the playback mode to the shooting mode
  - Executing [Image Copy], [Resize], or [Cropping] of the  menu
  - Executing [Format [Card]] or [Format [Internal M]] of the  menu

## Copying Images

Images can be copied between the internal memory and the memory card.

- 1** Insert a memory card.
- 2** Select [Image Copy] in the  menu, and press .
- 3** Select the copy method, and press **OK**.

[Internal M]>>>[Card]	Copies all images in the internal memory to the memory card. When the memory card space is insufficient, the images cannot be copied.
[Card]>>>[Internal M]	Copies images in the memory card to the internal memory one by one after confirming copying of each file. The file names are automatically changed.



## Protecting Images from Deletion

You can protect images to prevent them from being deleted accidentally.

**1** Select [Protect] in the  menu, and press .

**2** Select the protection method.

Select the method from [1 File], [Sel. Multiple], [Select All], and [Cancel All].

When [1 File] is selected, use   to display the previous/next image.

**3** Press **OK**.

When [Sel. Multiple] is selected, proceed to Step 4.

**4** Select [Sel. Individ.] or [Sel. Range].

**5** Select the images to protect.

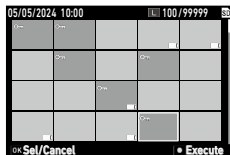

	Moves the selection frame.
<b>OK</b>	Selects/Deselects an image. When [Sel. Range] is selected: Selects the starting or ending point for image selection range.

**6** Press the green button.

The selected images are protected or unprotected.



**Memo** -----

- If you apply protection to the images that have already been protected, they are unprotected.



**Caution** -----

- If [Format [Card]] or [Format [Internal M]] of the  menu is executed, protected images are also deleted.

## Copying Images to a Computer

Connect the camera to a computer using the provided USB cable.

**1** Set [USB Connection] to [MSC] in the  menu.

**2** Open the battery/card cover of the camera, and connect the USB cable to the USB terminal.

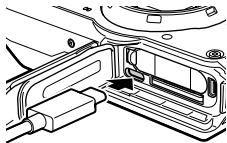

**3** Connect the USB cable to the USB port of the computer.

The camera is recognized as a device by the computer.

When a memory card is inserted, the files on the memory card are displayed.  
When a memory card is not inserted, the files in the internal memory are displayed.

**4** Copy the captured images to the computer.

**5** Disconnect the camera from the computer when the copy is complete.

**6** Remove the USB cable from the camera.

 **Caution** -----

- When opening and closing the battery/card cover, be sure to remove water and dirt such as sand adhering to the camera, and avoid locations where dirt can enter the camera interior.
- Do not remove the USB cable while copying images.

 **Memo** -----

- When the camera is connected to a computer and then turned off, the battery charging starts.
- Refer to "Operating Environment" (p.113) for system requirements to connect the camera to a computer.

## Editing and Processing Images

You can edit and process taken images.



### Caution

- Only images taken with this camera can be edited and processed. Still images saved from movies cannot be edited and processed.
- If you edit and process images repeatedly, image quality will deteriorate.

## Changing the Image Size

4

### Changing the Number of Recorded Pixels (Resize)

Playback Functions

**1** Display an image in the single image display of playback mode.

**2** Select [Resize] in the  menu, and press .

The [Resize] screen appears.

**3** Set [Recorded Pixels] and [Quality Level] for the resized image.

The smaller size than the setting for shooting can be selected.

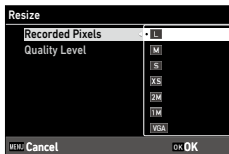

**4** Press **OK**.

**5** Select [Overwrite] or [Save as], and press **OK**.

The image is saved.

## Cropping Images







You can crop a part of images and then save them.

**1** Display an image in the single image display of playback mode.

**2** Select [Cropping] in the **▶** menu, and press **▶**.  
The [Cropping] screen appears.

**3** Specify the range to crop.



 (T) /  (W)	Changes the cropping size.
   	Moves the cropping frame.

**4** Press **OK**.  
The image is saved as a new image.

## Processing Images with Filters

You can process images with filters.

- 1 Display an image in the single image display of playback mode.
- 2 Select [Filter] in the **▣** menu, and press **▶**.  
The [Filter] screen appears.
- 3 Use **▲▼** to select a filter, and press **▶**.

Small Face Filter	[5%], [7%], [10%]
Ink Rubbing Filter	[1] to [5]
Digital Filter	[B&W/Sepia], [Toy Camera], [Retro], [Color], [Extract Color], [Color Emphasis], [High Contrast], [Starburst], [Soft], [Fish-eye], [Miniature], [Brightness]
HDR Filter	—

When [HDR Filter] is selected, proceed to Step 5.

- 4 Use **◀▶** to specify a value.  
For [Digital Filter], use **▲▼** to select a filter type, and then use **◀▶** to specify a value.

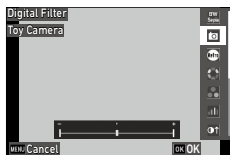

- 5 Press **OK**.
- 6 Select [Overwrite] or [Save as], and press **OK**.  
The image is saved.

- 1 Select [Movie Edit] in the **▶** menu, and press **▶**.  
The [Movie Edit] screen appears.

- 2 Use **▲▼** to select an editing method.

Save as Still Image	Saves the specified frame as a still image.
Divide Movies	Divides a movie into two files at the specified division point and saves as new files.
Adding title picture	Specifies the image to be used as the thumbnail for a movie.

For each editing method, refer to the following.

### Saving the Specified Frame as a Still Image

- 1 Select [Save as Still Image], and press **OK**.  
The movie playback screen appears.

- 2 Display the frame to save.  
You can play or pause the movie in the same manner as when viewing a movie in the playback mode.



- 3 Press **OK**.  
The selected frame is saved as a still image.

## Dividing a Movie

- 1 Select [Divide Movies], and press **OK**.  
The movie playback screen appears.
  - 2 Display the frame at which you want to divide the movie.  
You can play or pause the movie in the same manner as when viewing a movie in the playback mode.  
The dividing point can be specified in 30 frames increments.
  - 3 Press **OK**.  
The confirmation screen appears.
  - 4 Select [Divide], and press **OK**.  
The movie is divided at the selected frame and saved as new movie files.
- Caution** -----
- The movies with a recording time of less than 2 seconds cannot be divided.

## Specifying the Image to Be Used as the Thumbnail for a Movie

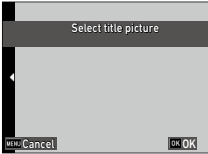
- 1 Select [Adding title picture], and press **OK**.  
The image selection screen appears.
  - 2 Use **◀▶** to select an image.
- 
- 3 Press **OK**.
  - 4 Specify whether to insert the image at the beginning or at the end of the movie, and press **OK**.  
The image is inserted at the beginning or end of the movie.





### Memo

- The inserted image is displayed for 3 seconds at the beginning or end of the movie.
- When the image is inserted at the beginning of the movie, it is displayed as the thumbnail for the movie. When the image is inserted at the end of the movie, the thumbnail for the movie is not changed.





### Caution

- When the recording time of the movie reaches 26 minutes with the title image inserted, the image cannot be inserted.

## Correcting Red Eyes in Images

You can correct red eyes in images taken with a flash.

- 1** Display an image in the single image display of playback mode.
- 2** Select [Red-eye Edit] in the  menu, and press .
- 3** Select [Overwrite] or [Save as], and press **OK**.  
The image is saved.



### Caution

- The red eyes cannot be corrected for the following images.
  - Images in which the camera cannot detect red eyes
  - Movies

## Saving Frequently Used Settings

### Using the Mode Dial

You can assign frequently used shooting settings to the mode dial **U1** and **U2** so that you can easily recall the settings.

The following settings can be saved.

- Capture mode
- / menu settings (with exceptions)
- A part of **C** menu settings

5

### Saving the Settings

- 1** Set the capture mode and all the necessary settings to save.
- 2** Select [Reg. USER] in the **C** menu, and press **▶**.
- 3** Select [U1] or [U2], and press **OK**.  
The settings are saved.

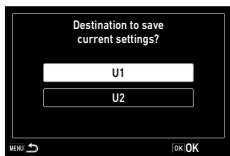

### Using the User Mode

- 1** Set the mode dial to **U1** or **U2** in the shooting mode.
- 2** Change the settings as necessary.

- Memo** -----
- The settings changed in Step 2 are not saved in the camera. If the mode dial is turned, the settings are reset to the saved settings.

## Exporting the Settings to a File

You can export the menu settings to a file and save it in a memory card. The settings can be restored from the exported file. Also, the settings can be copied to multiple cameras using the exported file.

You can export the settings in a memory card using [Write] and can import the settings to the camera using [Read] in [Camera Settings File] of the  menu.



### Caution

- The setting file is saved in the "SYSTEM" folder in the memory card with the file name "CAMERA.PRM". When [Write] is executed, the old file is overwritten.
- If the memory card is not available for recording, the setting file cannot be saved.

# Customizing the Button Functions

## Registering Functions to the Movie Button

You can change the settings for “ADJ. mode” of which functions can be easily used by pressing the movie button.

Five functions selected from the following functions can be saved. (The functions indicated with a square-bracketed item are the default settings for the item.)

- Off
- EV Comp. [Setting1]
- Recorded Pixels [Setting2]
- Aspect Ratio [Setting3]
- ISO Setting [Setting4]
- White Balance [Setting5]
- Image Tone
- Quality Level
- AE Metering
- AF
- Face Detection
- Highlight Cor.
- Shadow Cor.
- Outdoor View

5

Changing the Settings

**1** Select [ADJ Button Setting 1] to [ADJ Button Setting 5] in the **C** menu, and press **▶**.

**2** Use **▲▼** to select a function, and press **OK**.

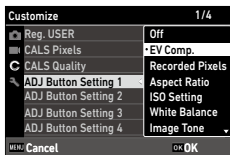

**3** Set [Movie Button] to [Off] in the **C** menu.  
The ADJ. mode is enabled.



**Memo** -----

- Refer to “Using the ADJ. Mode” (p.20) for how to use the ADJ. mode.

## Changing the Functions of the Green Button

You can change the functions activated when the green button is pressed. The following functions can be saved.

### Still images

- Green Mode (default setting)
- EV Comp.
- Recorded Pixels
- Quality Level
- Aspect Ratio
- White Balance
- ISO Setting
- AF
- Face Detection
- Auto Macro
- AE Metering
- Highlight Cor.
- Shadow Cor.
- Sharpness
- Saturation/Tone Adjustment
- Contrast
- Outdoor View

### Movies

- Green Mode (default setting)
- Movie SR
- Movie SR+
- White Balance
- AF
- Face Detection
- EV Comp.
- Sharpness
- Saturation/Tone Adjustment
- Contrast
- Outdoor View

**1** Select [Green Mode] in the **C** menu, and press **▶**.

**2** Use **▲▼** to select a function, and press **OK**.

The green button function is changed.

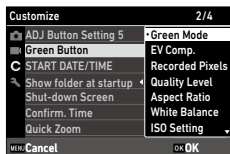

#### Memo

- You can display the current green button function when the camera is turned on. Set [Start-up Screen] to [Start-up screen with operation guide] in the **▶** menu. (p.84)
- The function set to the green button is enabled in the shooting mode only.

## Display and Sound Settings

### Setting the Start-up Screen

The screen display when the camera is turned on can be set in [Start-up Screen] of the  menu.

Start-up screen with operation guide	Displays the capture mode.
PENTAX	Displays the PENTAX logo.
Photographs	Displays the selected captured image.
Off	Displays nothing.

5

Changing the Settings

### Setting the Information Displayed when the Camera Is Turned On/Off

You can set the information displayed when the camera is turned on and off in the  menu.

START DATE/TIME	Displays the current date and time until the camera is operated after it is turned on.
Show folder at startup	Displays the name of the current folder and the number of images in the folder until the camera is operated after it is turned on.
Shut-down Screen	Displays the PENTAX logo and the number of images captured on the day except for deleted images when the camera is turned off.

### Setting the Live View Display

You can set the Live View display in the  menu.

Grid Guide Display Op.	Select the grid style from [9 Divide] or [16 Divide].
Level Setting	Select the level display from [Off], [Level + Shift], or [Level].



#### Memo

- The current tilt can be saved as a reference tilt by executing [Calibrate Level] in the  menu.

## Setting the Brightness of the Monitor

You can adjust the brightness of the monitor in the  menu.

LCD Brightness	Sets the brightness of the monitor.
Outdoor View	Adjusts the brightness of the monitor when the monitor display is difficult to see during outdoor shooting or in other situations.



### Caution

- The [LCD Brightness] setting cannot be changed when [Outdoor View] is set.

## Setting the Lamp

You can set whether to turn the power button lamp on when the power is turned on in [Power Button Lamp] of the  menu.

## Setting the Sound Volume

You can set the sound volume in the  menu.

Operation Volume	Sets the sound volume when buttons are operated.
Playback Volume	Sets the sound volume during playback.
Sound	Sets the sound volume for [Startup Sound], [Shutter Sound], [Operation Sound], and [Self-timer Sound].

## Power Saving Settings

### Automatically Turning the Power Off

The camera turns off automatically if no operations are made for a certain period of time. Set the time until the the camera is turned off in [Auto Power Off] of the  menu.



#### Memo

- [Auto Power Off] is not available in the following cases.
  - During shooting in the  mode or in [Interval Shooting] of the **SCN** mode
  - During movie playback or slideshow
  - During data processing
  - While the camera is connected to a computer
  - During FlashAir connection

5

### Dimming the Display

The camera dims or turns off the display automatically if no operations are performed during the set time. The following settings can be set in the  menu.

Power Saving	Dims the display automatically if no operations are performed during the set time to suppress battery drain. Select the time until the display is dimmed from [5sec.], [15sec.], [30sec.], [1min.], and [2min.].
Monitor Auto off Delay	Turns the monitor off automatically if no operations are performed during the set time. Select the time until the the monitor is turned off from [1min.], [5min.], and [30min.].



If the camera is operated, the original brightness and display are restored.





## Memo

---

- [Power Saving] is not available in the following cases.
  - During shooting in the  mode or in [Interval Shooting] of the **SCN** mode
  - In the  mode
  - In the  mode
  - While a menu is displayed
  - While the AC adapter is used
- [Monitor Auto off Delay] is not available in the following cases.
  - During shooting in [Interval Shooting] of the **SCN** mode
  - During movie playback or slideshow
  - While the camera is connected to a computer

## Setting the GPS

The camera can acquire information from GPS satellites using the built-in GPS function.



### Caution

- After the GPS function is turned on, the camera periodically acquires GPS information even when the camera is turned off, which drains the battery.
- Local geographic conditions such as places where radio waves are blocked or reflected may prevent or delay the acquisition of GPS information.
- The positions of GPS satellites are continuously changing and this may prevent or delay the acquisition of GPS information.
- The presence of devices transmitting frequencies close to those of GPS satellites or devices generating a strong magnetic field may interfere with the acquisition of GPS information or deteriorate the GPS information precision.
- Note that the camera may take a while to acquire the GPS information if it has not been used for an extended period or has been moved a great distance from where the GPS information was last acquired.
- The presence of devices generating a strong magnetic field or devices blocking magnetic fields may interfere with the acquisition of correct direction information.
- The GPS function may not work near a broadcast tower, etc. and in a place where strong static electricity is generated.
- The use of GPS, the collection of location information, etc. may be regulated depending on the country and region. When bringing the camera to a foreign country, check with your embassy or travel agency beforehand if there are restrictions on bringing in the camera with the GPS function, logging GPS information, etc.

## Displaying the GPS Information

You can record the location information in images using the GPS function. Set in [GPS] of the **C** menu or press and hold **GPS** (**▶**) to turn the GPS function on and off. The GPS information is acquired every one second in the shooting mode.

The acquired GPS information can be checked in "Detailed information display" in the shooting mode (p.18).

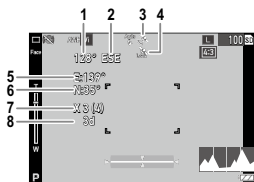

1	Electronic compass information (azimuth)
2	Electronic compass direction
3	GPS positioning status
4	GPS lock
5	Longitude
6	Latitude
7	Number of GPS satellites used (Number of acquired visible GPS satellites)
8	Positioning quality [no fix]: Positioning is not possible. [2d]: The GSA positioning mode in the NMEA-0183 format is "2d". [3d]: The GSA positioning mode in the NMEA-0183 format is "3d". [Diff]: The GGA quality in the NMEA-0183 format is "DGPS".



## Memo

- The standard of GPS information displayed on the monitor can be set in [GPS Disp Mode] of the **C** menu.

LAT/LON	Displays the latitude and longitude.
UTM	Displays the Universal Transverse Mercator (UTM) coordinates.
MGRS	Displays the Military Grid Reference System (MGRS) coordinates used as military information.

- The details of the location information recorded in images can be checked in “Detailed information display” in the playback mode (p.18).
- Set [GPS Lock] to [On] in the **C** menu to enable the function to protect the acquired GPS information. The GPS information is protected when **▶** is pressed on the shooting screen. The information is unprotected when **▶** is pressed again.

## Automatically Adjusting the Date and Time Settings

The camera date and time settings can be adjusted based on the GPS information by setting [GPS Time Adjustment] to [On] in the **C** menu.

## Recording the Camera Route

You can record the camera route using the GPS information.

- 1** Select [GPS Log] in the **C** menu, and press **▶**.  
The [GPS Log] screen appears.

- 2** Select [Record log], and press **OK**.



### 3 Set [Logging Interval] and [Logging Duration].



Logging Interval	Select from [1sec.] to [60sec.].
Logging Duration	Select from [1] hour to [24] hours.

### 4 Select [Start], and press **OK**.

GPS logging starts.

Select [Stop] to stop the GPS logging.

When the set logging time elapses, the GPS logging stops.



#### Caution

- If you attempt to perform shooting with [Interval Shooting] or [Interval Movie] of the **SCN** mode during the GPS logging, a warning message appears and shooting does not start.
- The logging interval may fluctuate in the following cases.
  - When the camera is being turned on or off
  - When the information of a new satellite is being acquired
- The time that can be set in [Logging Duration] varies depending on the [Logging Interval] setting. The data may be acquired about 1 minute longer than the time set in [Logging Duration].

## Saving Logs

You can save the recorded logs to the memory card as a file.

**1** Select [Save log data] on the screen in Step 2 on p.90, and press **▶**.

**2** Select [NMEA] or [KML], and press **OK**.

The log file is saved in the "GPSLOG" folder in the memory card with the file name composed of the serial number 001 to 999 and the month and day. (Example: 001\_0505)



### Memo

- You can check the log file by using a software supporting the file on a computer.
- When deleting the log file, select [Discard log data] on the screen in Step 2. The log file cannot be deleted with [Format [Card]] in the menu.



### Caution

- If the memory card is not available for recording, the log file cannot be saved.
- When the GPS information has not been acquired, the log file is not saved.

## Setting the Direction Information

You can set the direction information displayed on the shooting screen in the **C** menu.

Compass Heading	Sets the displayed information.
Compass Calibration	Executes the adjustment of the compass. Hold the camera with one hand and move it slowly like drawing the figure 8. When the adjustment is completed, a beep sounds.
Declination	Select from [TRUE] and [MAG]. When the GPS information has not been acquired, the information for [TRUE] is not displayed.

## Imprinting the GPS Information

The acquired GPS information can be imprinted at the bottom right of the image. Set in [Data Imprint] of the **C** menu.

GPS Data Imprint	Sets the standard of GPS information to imprint.
UTC Data Imprint	Imprints the Universal Coordinated Time. [Date Imprint] of the  menu is disabled.
Heading Data Imprint	Imprints the direction information.



### Caution

- The imprinted GPS information cannot be deleted.
- The GPS information cannot be imprinted in the following cases.
  - During the shooting in [Underwater Movie] or [High Speed Movie] of the **SCN** mode.
  - In the  mode
  - When [Drive Mode] is set to [Burst Shoot], [M-Cont], or [S-Cont]

## File Management Settings

### Specifying the Folder/File Settings

By default, folders and files are automatically named as follows.

Folder Name	100PENTX to 999PENTX
File Name	IMGP0001.JPG to IMGP9999.JPG





When the file number exceeds IMGP9999, the next folder is created and the file number becomes IMGP0001. If the file number exceeds IMGP9999 when the folder number is 999, no more files can be stored on the memory card currently inserted.

The folder and file names can be changed.

5

### New Folder Options

When images are captured with this camera, a folder is automatically created and the captured images are stored in it. Each folder name consists of a sequential number from 100 to 999 and a string of 5 characters. The character string in the folder name can be changed.

- 1 Select [New folder options] in the  menu, and press .
- 2 Use   to select a setting.

Standard	100PENTX to 999PENTX
Date	Assigns four digits of the month and day of the shooting date after the folder number. The month and day appear according to the date format set in [Date Adjustment] of the  menu. Example) 101_0125: Images taken on January 25th
Custom	Assigns a freely defined string of five characters after the folder number. (Default: PENTX) Example) 101PENTX

When [Standard] or [Date] is selected, proceed to Step 6.



### 3 Select [Custom], and press ►.

The text-entry screen appears.

### 4 Enter a folder name.

Up to five single-byte alphanumeric characters can be entered.



▲▼◀▶	Moves the text selection cursor (yellow frame).
OK	Enters a character selected with the text selection cursor.

### 5 After entering the text, move the text selection cursor to ←, and press OK.

### 6 Select [Execute], and press OK.



#### Memo

- A folder with a new number is created when the next shooting is performed after the folder name is changed.





#### Caution



- The maximum folder number is 999. If the folder name is changed after the folder number reaches 999, you cannot capture new images. Also, you cannot capture new images when the file name number reaches 9999.

## File Name

The string of characters "IMGP" is used as the file name prefix by default. You can change this to any string of characters.

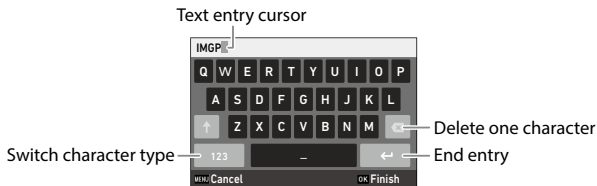
- 1 Select [File name] in the  menu, and press .
- 2 Select [Custom], and press .
- 3 Select a character to enter.  
Uppercase alphanumeric characters and "\_" can be entered.



 	Moves the text selection cursor (yellow frame).
	Enters a character selected with the text selection cursor.

- 4 After entering the text, move the text selection cursor to , and press .

## File Sequence No.

In [File Sequence No.] of the  menu, you can set whether to continue the sequential numbering for file names even when memory cards are replaced.

On	Continues the sequential numbering for file names even after memory cards are replaced.
Off	Resets the numbering for file names after memory cards are replaced.

## Reset File Number

If [Reset File Number] of the  menu is executed, a folder with a new number is created and file number starts from 0001.



### Memo

- When a memory card is not inserted, the file number in the internal memory is reset.

## Setting the Copyright Information

You can set the copyright information embedded in the Exif data.

**1** Select [Embed Info] in the  menu, and press **▶**.

**2** Select [On] or [Off], and press **OK**.

**3** Select [Copyright Info], and press **▶**.  
The text-entry screen appears.

**4** Enter the copyright holder.  
Up to 32 single-byte alphanumeric characters and symbols can be entered.



	Moves the text selection cursor (yellow frame).
<b>OK</b>	Enters a character selected with the text selection cursor.

**5** After entering the text, move the text selection cursor to **←**, and press **OK**.

The  menu reappears.

The first 11 characters of the entered copyright holder are displayed.



### Memo

- You can check the copyright information in “Detailed information display” in the playback mode (p.18).



## Imprinting the Copyright Information

The copyright information can be imprinted at the bottom of the image. Set in the  menu.

Copyright Print	Select from [On(OVR)], [On(New)], and [Off].
Copyright Position	Select from [Left], [Middle], and [Right].
Copyright Font Size	Select from [Large], [Middle], and [Small].
Copyright Color	Select from [Orange], [White], [Black], [Red], [Blue], [Green], and [Yellow].





### Caution

- The imprinted copyright information cannot be deleted.
- The copyright information cannot be imprinted in the following cases.
  - During the shooting in [Underwater Movie] or [High Speed Movie] of the **SCN** mode.
  - In the  mode
  - When [Drive Mode] is set to [Burst Shoot], [M-Cont], or [S-Cont]
  - When [Copyright Info] is not set in the  menu
- When [Copyright Font Size] is set to [Large] or [Middle], a part of the copyright information may not be imprinted.

## Saving the Local Date and Time of the Specified City

The date and time set in "Initial Settings" (p.35) serve as the date and time of your present location and are reflected in the shooting date and time for images.

Setting the destination to a location other than your present location enables you to save images time-stamped with the local date and time.

- 1 Select [World Time] in the  menu, and press .

The [World Time] screen appears.

- 2 Select [Destination] in [Select Time].

Select [Hometown] to reset the date and time to the ones of your present location.

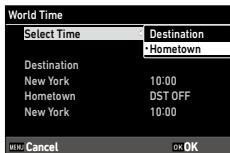

- 3 Press  at [Destination], and set the daylight saving time.

If the daylight saving time is applied to the city to set, turn [DST] on.

- 4 Press  at the city name row, and select the destination city.

The destination city can be selected from 75 cities.



- 5 Press .



Memo

- Even if [Reset] of the  menu is executed, the [Hometown] and [Destination] settings are not reset.

## Attaching Optional Accessories

### Wide Conversion Lens

If the wide conversion lens (DW-5) is attached to the camera, you can perform shooting with the 0.8x lens magnification (35 mm equivalent focal length: 22 mm (wide angle)).

When using the wide conversion lens, set [Lens Adapter On] to [WIDE] in the **C** menu. Refer to the User's Manual provided with the lens for details.



#### Memo

- A commercially available 37 mm diameter filter can be attached to the lens. This filter is effective to protect the camera from scratches and condensation.
- When [Lens Adapter On] is set to [WIDE] in the **C** menu, this setting information is recorded in the Exif data.



#### Caution

- When [Lens Adapter On] is set to [WIDE] in the **C** menu, the functions that can be set are restricted.

## AC Adapter

If you intend to use the camera continuously for a long period, the use of the AC adapter (K-AC166) is recommended.

- 1** Make sure that the camera is turned off, and open the battery/card cover.
- 2** Remove the battery.
- 3** Connect the USB cable (Type-C) of the AC adapter to the USB terminal of the camera.

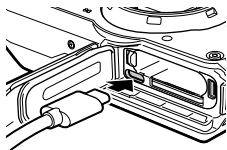

- 4** Connect the AC plug cord to the AC adapter, and plug the cord into the power outlet.

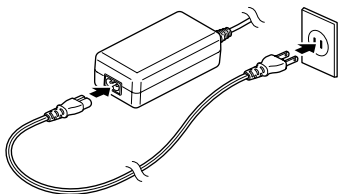

- 5** Turn the camera on.



### Caution

- When opening and closing the battery/card cover, be sure to remove water and dirt such as sand adhering to the camera, and avoid locations where dirt can enter the camera interior.
- Securely connect the power plug and AC plug cord.
- When the camera is not used, unplug the AC adapter from the power outlet and disconnect it from the camera.
- If the AC adapter is disconnected from the camera or the power plug is unplugged from the power outlet during use of the camera, the data may be lost.
- Do not move the camera by holding the AC adapter cable while the AC adapter is used.
- The AC adapter may not be usable depending on the country and region.



# Troubleshooting



## Power Supply

Problem	Cause	Solution	Page
The camera does not turn on.	The battery is not inserted.	Charge the battery and correctly insert it into the camera.	p.33
	The battery is exhausted.		
	The battery is not inserted in the correct orientation.		
	The battery is incompatible.	Use the battery DB-110 exclusively developed for this camera.	—
	The AC adapter is not correctly connected.	Connect the AC adapter correctly.	p.101
The camera turns off during use.	The [Auto Power Off] function has been activated because the camera was not operated for a certain period of time.	Turn the camera back on.	p.35
	The battery is exhausted.	Charge the battery.	p.33
The camera does not turn off.	The camera is malfunctioning.	Take the battery out and insert it again.	p.31
The low battery indicator is displayed or the camera turns off even when a fully charged battery is installed.	The battery is incompatible.	Use the battery DB-110 exclusively developed for this camera.	—
The battery cannot be charged.	The battery has reached the end of its service life.	Replace the battery with a new one.	—
	The battery is hot.	Let the battery cool down to ambient temperature.	—
The battery is quickly exhausted.	Ambient temperature is very high or very low.	—	—





## Shooting



Problem	Cause	Solution	Page
Shooting cannot be performed by pressing <b>SHUTTER</b> .	The battery is exhausted.	Charge the battery.	p.33
	The camera is turned off or not in the shooting mode.	Turn the camera on or press <b>SHUTTER</b> to switch the camera to the shooting mode.	p.35
	The memory card is not formatted.	Perform [Format [Card]] of the  menu.	p.37
	The memory card is full.	Insert a new card, or delete unwanted files.	p.70
	The memory card has reached end of its service life.	Insert a new memory card.	—
	The memory card is locked.	Unlock the card.	—
The memory card contacts are dirty.	Clean with soft, dry cloth.	—	
Images cannot be checked after shooting.	Confirmation time is too short.	Change the setting of [Confirm. Time] in the  menu.	p.38
The monitor is blank.	The monitor brightness is dark.	Adjust the brightness of the monitor in the  menu.	p.85
	The monitor is off.	Press <b>OK</b> to turn the monitor on.	p.18
	An AV device is connected to the camera.	Remove the cable from the camera.	p.69
The camera is unable to focus in autofocus mode.	The lens is dirty.	Clean with soft, dry cloth.	—
	The subject is not at center of frame.	Lock the focus for shooting.	—
	The subject is not suitable for autofocus.	Lock the focus or set the focus mode to [MF] for shooting.	p.51
	The subject is too close.	Use [Macro] for shooting or move away from the subject.	p.49
Images are blurred.	The camera was moved when <b>SHUTTER</b> is pressed.	Hold the camera with your elbows pressed against your body, or use a tripod.	—
	When shooting in a dark place, taken images become easily blurred.	Use a flash, or set [ISO Setting] to a high ISO sensitivity.	p.54 p.52
The flash does not discharge. The flash is not charged.	A function preventing flash operation is selected.	Check the settings and mode.	—
	The battery is exhausted.	Charge the battery.	p.33

Problem	Cause	Solution	Page
Images are too bright.	Flash output is not appropriate.	Move away from the subject or use a different light source.	—
	The monitor brightness is not appropriate.	Adjust the brightness of the monitor in the  menu.	p.85
Images are too dark.	The monitor brightness is not appropriate.	Adjust the brightness of the monitor in the  menu.	p.85
	The exposure compensation is set to a negative value.	Change the exposure compensation value.	p.43
The colors of images are unnatural.	The camera is unable to adjust white balance for shooting conditions using auto white balance.	Include a white object with the subject or select the settings other than [Auto WB] for [White Balance].	p.56
The monitor brightness changes during autofocus.	Ambient lighting is poor or differs from that used for autofocus.	This is normal and does not indicate a malfunction.	—
Electronic level indicators are not displayed.	Electronic level indicators are hidden.	Check the setting of [Level Setting] in the  menu.	p.84
The image is not level although level indicator showed that the camera was level.	The camera was moving during shooting because you were on a moving object or due to other causes.	Do not move the camera during shooting.	—
	The subject is not level.	Check the subject.	—



## Playback/Deletion

Problem	Cause	Solution	Page
Shooting information is not displayed.	Information display is set to "No information display".	Press <b>OK</b> to switch the information displayed on the screen.	p.18
Images cannot be played back. Images are not displayed on the monitor.	The AV device is not correctly connected with the camera.	Connect the cable correctly.	p.69
Images are not displayed on an AV device.	The cable is not correctly connected.	Connect the cable correctly.	p.69
	The input setting of the AV device is incorrect.	Check the AV device settings.	—
The images on the memory card cannot be played back. Images are not displayed on the monitor.	The inserted memory card is not formatted with this camera.	Insert a memory card formatted with [Format [Card]] of the  menu in this camera.	p.37
	The memory card contacts are dirty.	Clean with soft, dry cloth.	—
	The card is malfunctioning.	There is not problem with the camera if images in another memory card can be played back with this camera. Do not use a memory card that has a problem.	—
The monitor turned off.	The battery is exhausted.	Charge the battery.	p.33
	The [Auto Power Off] function has been activated because the camera was not operated for a certain period of time.	Turn the camera back on.	p.35
File(s) cannot be deleted.	[Protect] is set for the image(s).	Cancel the protection with [Protect] of the  menu.	p.72
	The memory card is locked.	Unlock the card.	—
The memory card cannot be formatted.	The memory card is locked.	Unlock the card.	—

## Others

Problem	Cause	Solution	Page
The memory card cannot be inserted.	The card is not in the correct orientation.	Insert the memory card in the correct orientation.	p.31
Camera controls have no effect.	The battery is exhausted.	Charge the battery.	p.33
	The camera is malfunctioning.	Turn the camera back on.	p.35
		Take the battery out and insert it again. When the AC adapter is used, reconnect it.	p.31
Date is not set correctly.	Date and time are not set correctly.	Set date and time correctly in the  menu.	p.36
The date setting has been reset.	The battery was removed.	If the battery is removed for more than about five days, the date setting will be lost. Set date and time in the  menu.	p.36

## Error Messages

Error Message	Description
Insufficient Memory	The memory is full and no more files can be saved. Insert a new memory card or delete unwanted files. (p.70)
No image	There are no files that can be played back.
Unmatched File	You are trying to play back a file in a format not supported by this camera. You may be able to play it back on a computer.
Memory card error	The memory card has a problem, and shooting and playback are impossible. You may be able to play back files on a computer.
Format card.	The memory card you have inserted is unformatted or has been previously used on another device. Use the card after formatting it with this camera. (p.37)
Card is locked	The write-protect switch on the memory card you have inserted is locked.
Files cannot be stored.	You are trying to record a movie when the internal memory is set as the save destination and [Recorded Pixels] is set to [4K 30fps] in the  menu. Change the [Recorded Pixels] setting or insert a memory card. (p.62)
Card Error	A memory card not compatible with this camera is inserted.
Set date.	The date and time are not set. Set the date and time. (p.36)
Insufficient memory. Continue?	Some files cannot be copied with [Image Copy] of the  menu because the memory card space is insufficient. Use another memory card or delete unwanted files.
The file selected for deletion is protected.	You are trying to delete a protected file. Cancel the protection. (p.72)
Format internal memory.	Format the internal memory. (p.37)

# Main Specifications

## Camera

<b>Lens</b>		PENTAX lens, 11 elements in 9 groups (5 aspherical lens elements)
	Focal Length	5 to 25 mm
	35 mm Equivalent Focal Length	Approx. 28 to 140 mm
	Maximum Aperture	F3.5 (W) to F5.5 (T)
<b>Zoom Magnification</b>	Optical Zoom	5x
	Digital Zoom	Approx. 8.1x
	Intelligent Zoom	10M: Approx. 7x 640: Approx. 40.5x (zoom magnification obtained together with the optical zoom)
<b>Motion Blur Reduction</b>	Still Image	Pixel Track SR High-sensitivity shake reduction mode (Digital SR)
	Movie	Movie shake reduction mode (Movie SR, Movie SR+)
<b>Focus</b>	Type	9-point AF, Spot AF, Auto tracking AF
	Focus Range (from lens face)	Standard: 0.5 m (1.64 ft) to ∞ (entire zoom range) Macro: 0.1 to 0.6 m (0.33 to 1.97 ft) (entire zoom range) 1cm Macro: 0.01 to 0.3 m (0.03 to 0.98 ft) (intermediate portion of the zoom range) Switchable to Infinity-landscape, Pan Focus, and Manual Focus
<b>Effective Pixels</b>		Approx. 20 megapixels
<b>Image Sensor</b>		1/2.3" CMOS
<b>Recorded Pixels</b>	Still Image	Size: L (20M), M (10M), S (5M), XS (3M), 2M, 1M, VGA <ul style="list-style-type: none"> <li>When the aspect ratio is set to 4:3, the sizes in parentheses are used.</li> <li>2M and 1M are available only in the <b>CALS</b> mode.</li> </ul> Aspect ratio: 4:3, 3:2, 1:1 <ul style="list-style-type: none"> <li>In the <b>CALS</b> mode, the aspect ratio is fixed to 4:3.</li> </ul>
	Movie	4K, 1920, 1280
<b>Sensitivity (standard output)</b>		Auto, Manual (ISO 125 to 6400)
<b>White Balance</b>		Auto, Daylight, Shade, Cloudy, Tungsten, Fluorescent (D: Daylight color, N: Daylight white, W: Cool white, L: Warm white), Ring Light, Manual
<b>Monitor</b>	Type	3.0" LCD, Approx. 1040 K dots, With AR coating (cover only)
	Adjustment	Brightness, Outdoor view setting: ±2 steps

<b>Exposure Control</b>	Metering System	Multi-segment metering, Center-weighted metering, Spot metering
	Exposure Compensation	$\pm 2$ EV (1/3 EV steps)
<b>Capture Mode</b>		Auto Picture, Program, HDR, Handheld Night Snap, Movie, High Speed Movie, Digital Microscope, Landscape, Flower, Portrait, Underwater, Underwater Movie, Interval Shooting, Interval Movie, Surf & Snow, Kids, Pet, Sport, Night Scene, Fireworks, Digital SR, CALS, Green, DOF Composite
<b>Face Detection</b>		Maximum detectable faces: 30 Smile capture, Self-portrait assist, Self-portrait assist + Smile capture, Blink detection
<b>Pet Detection</b>		1 pet (Auto)
<b>Playback Mode</b>		Slideshow, Rotation, Small Face Filter, Ink Rubbing Filter, Digital Filter (B&W/Sepia, Toy Camera, Retro, Color, Extract Color, Color Emphasis, High Contrast, Starburst, Soft, Fish-eye, Brightness, Miniature), HDR Filter, Movie Edit, Red-eye Edit, Resize, Cropping, Image Copy, Protect, Start-up Screen, Recover File, Auto Image Rotation
<b>Shutter Speed</b>		1/4000 to 1/4 seconds (with the mechanical shutter and electronic shutter used together) Up to 4 seconds (in the Night Scene mode)
<b>Built-in Flash</b>	Mode	Auto flash, Flash off, Flash on, Auto flash + Red-eye edit, Flash on + Red-eye edit
	Flash Effective Range	Wide angle: Approx. 0.2 to 5.5 m (0.66 to 18 ft) (when the ISO sensitivity is set to Auto) Telephoto: Approx. 0.2 to 3.5 m (0.66 to 11 ft) (when the ISO sensitivity is set to Auto)
<b>Drive Mode</b>		Single-frame shooting, Self-timer, Continuous shooting, Burst shooting, M-continuous shooting, S-continuous shooting, Remote control, Auto bracketing
<b>Storage Media</b>		Internal memory (approx. 27 MB), SD/SDHC/SDXC memory card FlashAir™ card
<b>Power Supply</b>		Rechargeable battery DB-110, AC adapter kit K-AC166 (optional)
	Battery Life	Still image shooting: Approx. 340 images (with the rechargeable battery) <sup>*1</sup> Movie playback: Approx. 260 minutes (with the rechargeable battery) <sup>*2</sup>
<b>Interfaces</b>		USB 3.0 (Type-C), HDMI output terminal (Type D)
<b>Waterproof and Dustproof Rating</b>		Equivalent to JIS Class 8 waterproof and JIS Class 6 dustproof capabilities

<b>Dimensions</b>	Approx. 118.2 mm (W) × 65.5 mm (H) × 33.1 mm (D) (4.7 in. (W) × 2.6 in. (H) × 1.3 in. (D)) (excluding operating controls and protrusions)
<b>Weight</b>	Approx. 242 g (8.5 oz) (including the dedicated battery and SD memory card) Approx. 215 g (7.6 oz) (body only)
<b>Included Accessories</b>	Rechargeable battery DB-110, USB power adapter, Power plug, USB cable, Hand strap, Macro stand
<b>Language</b>	English, French, German, Spanish, Portuguese, Italian, Dutch, Japanese, Danish, Swedish, Finnish, Polish, Czech, Hungarian, Turkish, Greek, Russian, Thai, Korean, Simplified Chinese, Traditional Chinese
<b>GPS</b>	GPS, GLONASS GPS display mode: LAT/LON, UTM, MGRS GPS lock, GPS time adjustment, GPS logging, GPS data imprint, UTC data imprint
<b>Electronic Compass</b>	Compass display: Cardinal direction, Degrees, Cardinal direction + Degrees Declination correction, Heading data imprint
<b>Webcam Function</b>	Compliant with USB Video Class 1.1

\*1 Image storage capacity shows approximate number of images stored during CIPA-compliant testing. Actual results may vary depending on the shooting conditions/circumstances. (Excerpt from CIPA standard: With the monitor ON, with 50% use of flash, at 23°C (73°F))

\*2 According to the result of RICOH IMAGING in-house testing.



## USB Power Adapter AC-U2

<b>Power Supply</b>	100 to 240 VAC (50/60 Hz), 0.2 A
<b>Output</b>	5.0 VDC, 1000 mA
<b>Average Active Efficiency</b>	76%
<b>No-Load Power Consumption</b>	70 mW
<b>Operating Temperature</b>	0 to 40°C (32 to 104°F) * It depends on the operating temperature of the camera.
<b>Storage Temperature</b>	-20 to 60°C (-4 to 140°F)
<b>Dimensions</b>	42.5 mm (W) × 22 mm (H) × 66.5 mm (D) (excluding the power plug)
<b>Weight</b>	Approx. 40 g (excluding the power plug)

## Rechargeable Battery DB-110

<b>Nominal Voltage</b>	3.6 V
<b>Rated Capacity</b>	1350 mAh, 4.9 Wh
<b>Operating Temperature</b>	0 to 40°C (32 to 104°F)
<b>Storage Temperature</b>	-10 to 45°C (14 to 113°F)
<b>Dimensions</b>	39.8 mm (W) × 34.2 mm (H) × 8.5 mm (D)
<b>Weight</b>	Approx. 26 g

## Image Storage Capacity

The following table shows the approximate number of images and recording time (in seconds) of movies that can be saved in the internal memory and a memory card in various formats.

	Recorded Pixels	Aspect Ratio	Internal Memory			Memory Card (8 GB)		
			☆☆☆☆	☆☆	☆	☆☆☆☆	☆☆	☆
Still image	L	4:3	3	6	9	936	1616	2537
		3:2	3	6	10	1053	1815	2843
		1:1	4	8	12	1242	2145	3324
	M	4:3	7	12	18	1858	3189	4917
		3:2	7	13	20	2088	3522	5488
		1:1	9	15	24	2458	4140	6378
	S	4:3	11	22	31	3146	5900	8138
		3:2	13	25	35	3522	6556	9077
		1:1	15	29	40	4214	7867	10728
	XS	4:3	18	34	45	4816	9077	11801
		3:2	20	37	51	5364	9834	13112
		1:1	27	48	63	7152	12422	16858
	2M	4:3	28	51	66	7613	13112	16858
	1M	4:3	35	59	77	9077	15734	19668
	VGA	4:3	137	223	297	33717	59005	78673
3:2		148	255	297	39336	59005	78673	
1:1		178	297	357	47204	78673	78673	

	Recorded Pixels	Framerate	Internal Memory	Memory Card (8 GB)
Movie	3840	30 fps	—	00:10:19
	1920	30 fps	00:00:06	00:52:04
	1280	60 fps	00:00:06	00:52:04
		30 fps	00:00:14	01:26:04
		120 fps	00:00:02	00:32:41



## Caution

- The figures for movies are the total length that can be recorded. The maximum recording time per shooting is 25 minutes or the equivalent of 4 GB.
- The number of images that can be taken may differ from the number of storable images displayed on the monitor.
- The storage capacity varies depending on the shooting conditions and the capacity of the memory.
- The memory cards with which proper operation has been confirmed are listed below.

Recorded Pixels/Capture Mode	Memory Card Speed Class
4K 30fps	UHS Speed Class 3 or faster
FullHD 30fps, HD 60fps [High Speed Movie] in the <b>SCN</b> mode	Speed Class 4 or faster
HD 30fps	Speed Class 2 or faster

- If a movie is recorded with a memory card with which proper operation has not been confirmed, the movie recording stops when writing to the card is delayed. (The movie recorded by the time the recording stops is saved.) If a movie is played back with such a card, the playback sound does not synchronize with the video.

## Operating Environment

It is confirmed that a USB connection can be established between the camera and the following OSs.

Windows®	Windows® 11, Windows® 10
Mac	macOS 14 Sonoma, macOS 13 Ventura, macOS 12 Monterey, macOS 11 Big Sur

## Using the Camera Abroad

### **USB Power Adapter (AC-U2), AC Adapter (K-AC166), and Battery Charger (BJ-11)**

These products are for use with currents of 100 to 240 V and 50 or 60 Hz. Before traveling, purchase a travel adapter for connection to the type of outlets used at your destination.

Do not use these products with electrical transformers, as this could damage the camera.

### **Television Playback**

Captured images can be played back on the televisions and monitors equipped with a video input terminal. Use a commercially available HDMI® cable. Use an HDMI® cable with a length of 3 m or less (recommended product: CAC-HD14EU15BK manufactured by ELECOM). The RICOH HDMI cable HC-1 cannot be used.

## Precautions for Use

### Waterproof and Dustproof Function

- The camera complies with JIS/IEC waterproof grade 8 and JIS/IEC dustproof grade 6 (IP68).
- After shooting in the rain or washing with water, water may leak out from the lens barrel or the tripod screw hole on the bottom of the camera. However, this is not problematic because the camera is protected with the double-layered structure.
- The interior of the camera does not have the waterproof/dustproof structure. If water enters inside the camera, immediately remove the battery and consult your nearest repair center.

### Camera

- When opening and closing the battery/card cover, be sure to remove water and dirt such as sand, mud, and dust adhering to the camera, and ensure that water or dirt does not enter the camera interior. Do not open the cover of the camera on the beach, at sea, or in a sandy area. If the cover is opened, seawater or sand may enter the camera.
- When opening and closing the battery/card cover, do not wear cotton work gloves. Dirt such as sand and dust adhering to the gloves may enter the camera interior. Also, be sure to remove water and dirt such as sand and mud adhering to the camera, and avoid locations where dirt can enter the camera interior.
- When the cover is opened, water droplets may be on the inside of the cover. In this case, clean them out before use.
- If the mode dial is not operated for a long time, it may become difficult to turn due to its waterproof structure. Turning the dial several times recovers the smooth dial operation.
- On the beach or in dusty places such as a construction site, be careful to keep the camera away from sand and dust.
- Do not leave the camera in places where temperature abnormally rises or in places in high humidity, such as in a car, on the beach, and in a bathroom.
- Ensure that the camera is turned off before connecting the optional AC adapter.
- Do not pull the battery/card cover forcefully.
- Do not hold the battery/card cover when carrying the camera.
- If any metallic object, water, liquid, or other foreign object gets into the camera, immediately stop using the camera. Turn the camera off, remove the battery and memory card from the camera, and contact your nearest dealer or service center for repair.
- In cold climates, water droplets on the camera may freeze. Using the camera with frozen water droplets could result in product malfunction. Do not leave the camera with water droplets.
- Do not drop the camera or subject it to physical shocks.

- When carrying the camera, be careful that it does not strike other objects. Particular care is required to protect the lens and monitor.
- The flash may overheat if fired many times in succession. Do not use the flash successively more than necessary.
- Do not use the flash in close contact with your body or other objects. Failure to observe this precaution could result in burns or fire.
- Using the flash unit in close proximity to your subject's eyes could cause temporary visual impairment. Particular care should be observed when photographing infants.
- Do not direct the flash at the operator of a motor vehicle. Failure to observe this precaution could cause accidents.
- Battery may become hot with extended use. Wait for the battery to cool before removing it from the camera.
- The monitor may be difficult to read in direct sunlight.
- You may notice that monitor varies in brightness or contains pixels that do not light or that are always lit. This is common to all LCD monitors and does not indicate a malfunction.
- Do not apply force to the monitor.
- Abrupt changes in temperature may cause condensation, resulting in visible condensation inside the lens or camera malfunction. This can be avoided by placing the camera in a plastic bag to slow the temperature change, and removing it only after the air in the bag has reached the same temperature of its surroundings. When condensation occurs, remove the battery and memory card from the camera, and wait until water droplets disappear.
- To prevent damage to the product, do not insert objects into the holes in the microphone and speaker coverings.
- Take a test shot to ensure that the camera is functioning properly before using it on important occasions such as travel or weddings. We recommend that you keep this manual and spare batteries at hand.



#### **Conditions that May Cause Condensation**-----

- If you move to an area with a sharply different temperature
- If humidity is high
- In a cold room after the heater has come on, or where the camera is exposed to cold air from an air conditioner or other device

### **USB Power Adapter AC-U2**

- Use the USB cable contained in the package.
- Do not subject the power adapter to severe impact or force.
- Do not use in extreme high or low temperatures or areas subject to vibration.
- Do not use in an area subject to direct sunlight or high temperature.
- Unplug the power plug from the power outlet after charging. Failure to observe this precaution could result in fire.

- Do not allow other metallic objects to come in contact with the connectors, or contacts of the rechargeable battery as this can result in a short.
- The operating temperature range is 10 to 40°C (50 to 104°F). Charging takes longer at temperatures below 10°C (50°F).

## Rechargeable Battery DB-110

- This is a lithium-ion battery.
- The battery is not fully charged at the time of purchase, so be sure to charge the battery before use.
- Do not open or damage the battery as this can result in fire or injury. In addition, do not heat the battery above 60°C (140°F) or expose the battery to fire.
- Due to the battery characteristics, the battery usage time may be shortened when used in a cold environment, even if the battery is fully charged. Keep the battery warm by placing it in a pocket or have a backup battery ready.
- When not in use, be sure to remove the battery from the camera or the battery charger. A small amount of current can leak from the battery even when the power is off, creating excessive discharge and making the battery unusable. If the battery is removed for more than five days, the date and time settings will be lost. In this case, reset the date and time.
- If the battery is not used for a long time, charge the battery for 15 minutes once a year before storing.
- Store in a dry, cool place with an ambient temperature between 15°C and 25°C (59°F and 77°F). Avoid storing in extreme high or low temperatures.
- After charging the battery, do not immediately charge it again.
- Charge the battery at an ambient temperature between 10°C and 40°C (50°F and 104°F). Charging the battery at a high temperature can deteriorate the battery. Charging at a low temperature may prevent full charging.
- If the battery usage time becomes very short even when fully charged, the battery has reached the end of its service life. Replace with a new battery. Be sure to use a replacement battery recommended by RICOH IMAGING.
- The charging time when charging with the AC-U2 while the battery is in the camera is approximately 3 hours (at 25°C (77°F)).



### Caution

---

- Use of other batteries can cause explosion.
- Recycle used batteries in a recycle box at your local electronics store or supermarket.

# Camera Care and Storage

## Caring for the Camera

- Image quality can be affected by fingerprints and other foreign matter on the lens. Avoid touching the lens with your fingers.
- Remove dust or lint on the lens with a commercially available blower, or gently clean the lens with a soft, dry cloth.
- When the camera becomes dirty or after using it on the beach, ensure that the battery/card cover is closed, and then rinse off dirt, sand, and salt in a basin of tap water and wipe off the moisture with a soft, dry cloth.
- When the rubber packing becomes dirty, clean it with soft, dry cloth. Dirt adhering to the rubber packing or scratches on it may deteriorate the waterproof function, causing water leakage. When the dirt cannot be cleaned or you find scratches on the rubber packing, take the camera to your nearest dealer or service center to replace it with a new packing.
- In the unlikely event of malfunction, consult your nearest repair center.
- The camera contains high-voltage circuits. Do not disassemble it.
- Do not expose the camera to volatile substances such as thinner, benzene, or pesticides. Failure to observe this precaution could result in damage to the camera or its coatings.
- The monitor is easily scratched, avoid touching it with hard objects.
- Clean the monitor by wiping it with a soft cloth dampened with a small amount of any monitor cleaner that does not contain organic solvents.

## Storage

- Do not store the camera where it will be exposed to:
  - Extreme heat or humidity, large changes in temperature or humidity
  - Dust, dirt, sand
  - Severe vibration
  - Prolonged contact with chemicals including pesticides, or with vinyl or rubber products
  - Strong magnetic fields (for example, in the vicinity of a monitor, transformer, or magnet)
- Store the camera in a lint-free camera case, etc. to prevent dirt and lint from adhering to the camera. Do not carry the camera in a pocket to prevent dirt and lint from adhering to the camera.
- Remove the battery if the product is left unused for a long period of time.



## Replacement of Rubber Packings

- Replace the rubber packing with a new one every two years even if it is not dirty and there is no problem with it, to maintain the waterproof function. When the camera is frequently used in water, in a sandy area, or in a dusty room, it is recommended to replace it every year. Contact your service center to replace the rubber packing. (A fee will be charged for the replacement.)

## Before Cleaning

- Be sure to turn the camera off.
- Remove the battery and AC adapter from the camera.

## Warranty Policy

All our cameras purchased through authorized bona fide photographic distribution channels are guaranteed against defects of material or workmanship for a period of twelve months from the date of your purchase. Service will be rendered, and defective parts will be replaced without cost to you within that period, provided the camera does not show evidence of impact, sand or liquid damage, mishandling, tampering, battery or chemical corrosion, operation contrary to operating instructions, or modification by an unauthorized repair shop. The manufacturer or its authorized representatives shall not be liable for any repair or alterations except those made with its written consent and shall not be liable for damages from delay or loss of use or from other indirect or consequential damages of any kind, whether caused by defective material or workmanship or otherwise; and it is expressly agreed that the liability of the manufacturer or its representatives under all guarantees or warranties, whether expressed or implied, is strictly limited to the replacement of parts as hereinbefore provided. No refunds will be made on repairs by non-authorized service facilities.

### Procedure During 12-month Warranty Period

Any camera which proves defective during the 12-month warranty period should be returned to the dealer from whom you purchased the camera or to the manufacturer. If there are no representatives of the manufacturer in your country, send the camera to the manufacturer, with postage prepaid. In this case, it will take a considerable length of time before the camera can be returned to you owing to the complicated customs procedures required. If the camera is covered by warranty, repairs will be made and parts replaced free of charge, and the camera will be returned to you upon completion of servicing. If the camera is not covered by warranty, regular charges of the manufacturer or of its representatives will apply. Shipping charges are to be borne by the owner. If your camera was purchased outside of the country where you wish to have it serviced during the warranty period, regular handling and servicing fees may be charged by the manufacturer's representatives in that country. Notwithstanding this, your camera returned to the manufacturer will be serviced free of charge according to this procedure and warranty policy. In any case, however, shipping charges and customs clearance fees to be borne by the sender. To prove the date of your purchase when required, please keep the receipt or bills covering the purchase of your camera for at least a year. Before sending your camera for servicing, please make sure that you are sending it to the manufacturer's authorized representatives or their approved repair shops, unless you are sending it directly to the manufacturer. Always obtain a quotation for the service charge, and only after you accept the quoted service charge, instruct the service station to proceed with the servicing.

- **This warranty policy does not affect the customer's statutory rights.**
- **The local warranty policies available from our distributors in some countries can supersede this warranty policy. Therefore, we recommend that you review the warranty card supplied with your product at the time of purchase, or contact our distributor in your country for more information and to receive a copy of the warranty policy.**

## For Customers in USA and Canada

### Conditions of RICOH IMAGING North America Warranty

1. RICOH IMAGING products originally distributed by RICOH IMAGING AMERICAS CORPORATION and RICOH IMAGING CANADA and purchased through our authorized distribution channels, are warranted by RICOH IMAGING AMERICAS CORPORATION and RICOH IMAGING CANADA to the original retail purchaser for a period of one year from date of purchase against defects in material and/or workmanship.
2. This warranty is limited to repair of defects in material and/or workmanship. These repairs will be made at no charge to the customer. However, all charges related to shipping the product to the service center are the responsibility of the owner. (Note: RICOH IMAGING AMERICAS CORPORATION and RICOH IMAGING CANADA will not assume the responsibility for damages or loss encountered in transit to the service center but will assist in processing any claims whenever possible.)
3. This warranty does not cover finishes or batteries, nor does it cover damages resulting from accident, misuse, abuse, dirt, water, sand, battery leakage, tampering, servicing performed or attempted by unauthorized service agencies. This warranty is valid only in the country where this product is purchased. Routine cleaning and normal cosmetic and mechanical wear are not covered under the terms of this warranty. RICOH IMAGING AMERICAS CORPORATION and RICOH IMAGING CANADA shall not be liable for any consequential or incidental damages resulting from any breach of warranty, express or implied, applicable to this product.
4. Please be sure to keep your original or a copy of your proof of purchase receipt (bill of sale), to obtain warranty service during the warranty period. The dated proof of purchase receipt (bill of sale) must be provided to ensure warranty status. If the dated proof of purchase receipt (bill of sale) is not received with the product, a repair estimate will be issued.

Some states do not allow limitations on how long an implied warranty lasts, so the above limitations may not apply to you. Some states do not allow the exclusion or limitation of incidental or consequential damages, so the above limitations may not apply to you. This warranty gives you specific rights and you may have other legal rights which vary from state to state. This warranty policy does not affect the consumer's statutory rights.

Register your product:

USA: <https://us.ricoh-imaging.com/register-product/>

CAN: <https://www.ricoh-imaging.ca/register-your-ricoh-imaging-product/>

For service-related inquiries:

USA: <https://us.ricoh-imaging.com/repairs/>

CAN: <https://www.ricoh-imaging.ca/support/repairs/>

For technical support:

USA: <https://us.ricoh-imaging.com/online-support/>

Tel: 1-800-234-0276

CAN: <https://www.ricoh-imaging.ca/support/digital-support/>

Tel: 1-800-224-6767

## Pour les utilisateurs aux États-Unis et au Canada

### Conditions de garantie RICOH IMAGING en Amérique du Nord

1. Les produits RICOH IMAGING distribués à l'origine par RICOH IMAGING AMERICAS CORPORATION et RICOH IMAGING CANADA et achetés par l'entremise de nos réseaux de distribution dûment agréés sont garantis par RICOH IMAGING AMERICAS CORPORATION et RICOH IMAGING CANADA contre tout défaut de fabrication et de main-d'œuvre pendant un an à partir de la date d'achat initiale pour l'acheteur original.
2. Cette garantie se limite aux réparations des défauts de fabrication et de main-d'œuvre. Ces réparations seront effectuées sans frais pour le client. Cependant, tous les frais reliés à l'envoi du produit dans un Centre de service seront à la charge de l'utilisateur. (Nota : RICOH IMAGING AMERICAS CORPORATION et RICOH IMAGING CANADA n'assumeront aucune responsabilité pour les dommages ou perte pouvant survenir lors du transport, mais assistera dans le traitement de toute réclamation dans la mesure du possible.)
3. Cette garantie ne couvre pas le fini ni les piles, et ne couvre pas non plus les dommages résultant d'un accident, d'une utilisation inappropriée ou abusive ainsi que de la poussière, eau, écoulement des piles, modifications ou réparations réalisées ou tentées par une agence de réparation non agréée. Cette garantie n'est valable que dans le pays où le produit a été acheté. Le nettoyage de routine et l'usure mécanique et esthétique ne sont pas couverts par cette garantie. RICOH IMAGING AMERICAS CORPORATION et RICOH IMAGING CANADA ne peuvent être tenues responsables des dommages accidentels, indirects et consécutifs résultant d'un manquement à une condition de la garantie, expresse ou implicite, applicable à ce produit.
4. Conservez votre bon d'achat original (facture de vente datée) ou une copie afin de fournir lors d'une demande de réparation pendant la période de garantie. Votre bon d'achat doit être fournie pour assurer l'état de la garantie. Si votre bon d'achat n'est pas reçue avec le produit, un devis de réparation sera émis.

Certains pays, états ne permettent pas de limiter la durée d'une garantie implicite, donc les limitations citées ci-dessus peuvent ne pas s'appliquer à vous. De même, certains pays, états permettent pas l'exclusion ou la limitation des dommages accidentels ou consécutifs, en conséquence, les limitations peuvent ne pas s'appliquer à vous. Cette garantie vous donne des droits spécifiques et vous pouvez avoir d'autres droits selon la juridiction en vigueur dans votre région. Cette garantie ne peut diminuer les droits juridiques du consommateur.

Renseignement relatif au service :

<https://www.ricoh-imaging.ca/fr/service-et-solution/repairs/>

Soutien technique :

<https://www.ricoh-imaging.ca/fr/service-et-solution/soutien-technique/>

## For Customers in USA

### STATEMENT OF FCC COMPLIANCE

#### Supplier's Declaration of Conformity 47 CFR § 2.1077 Compliance Information

Product Name: PENTAX WG-8

Model Number: R08050

This device complies with Part 15 of the FCC Rules. Operation is subject to the following two conditions: (1) This device may not cause harmful interference, and (2) this device must accept any interference received, including interference that may cause undesired operation.

Responsible party: RICOH IMAGING AMERICAS CORPORATION

Address: 2 Gatehall Drive Suite 204, Parsippany, New Jersey 07054, U.S.A.

Phone: 800-877-0155

Changes or modifications not expressly approved by the party responsible for compliance could void the user's authority to operate the equipment.

#### FCC Part 15 Subpart B Class B

This equipment has been tested and found to comply with the limits for a Class B digital device, pursuant to part 15 of the FCC Rules. These limits are designed to provide reasonable protection against harmful interference in a residential installation. This equipment generates, uses and can radiate radio frequency energy and, if not installed and used in accordance with the instructions, may cause harmful interference to radio communications. However, there is no guarantee that interference will not occur in a particular installation. If this equipment does cause harmful interference to radio or television reception, which can be determined by turning the equipment off and on, the user is encouraged to try to correct the interference by one or more of the following measures:

- Reorient or relocate the receiving antenna.
- Increase the separation between the equipment and receiver.
- Connect the equipment into an outlet on a circuit different from that to which the receiver is connected.
- Consult the dealer or an experienced radio/TV technician for help.

## FCC Part 15 Subpart C

This transmitter must not be co-located or operated in conjunction with any other antenna or transmitter.

The available scientific evidence does not show that any health problems are associated with using low power wireless devices. There is no proof, however, that these low power wireless devices are absolutely safe. Low power Wireless devices emit low levels of radio frequency energy (RF) in the microwave range while being used. Whereas high levels of RF can produce health effects (by heating tissue), exposure of low-level RF that does not produce heating effects causes no known adverse health effects. Many studies of low-level RF exposures have not found any biological effects. Some studies have suggested that some biological effects might occur, but such findings have not been confirmed by additional research. R08050 has been tested and found to comply with FCC radiation exposure limits set forth for an uncontrolled environment and meets the FCC radio frequency (RF) Exposure Guidelines.

### **CAUTION: RF Exposure**

To ensure compliance with the Radio Frequency (RF) exposure guidelines, this device must be used at least 5 mm away from your body or nearby persons. Failure to observe this warning could result in the RF exposure levels exceeding the applicable limits.

## SAFETY STANDARD FOR BUTTON CELL OR COIN BATTERIES AND CONSUMER PRODUCTS CONTAINING SUCH BATTERIES

This product contains a non-replaceable button cell or coin battery.

Do not replace the button cell or coin battery. This can cause a fire or electric shock.

### **WARNING**

- **INGESTION HAZARD:** This product contains a button cell or coin battery.
- **DEATH** or serious injury can occur if ingested.
- A swallowed button cell or coin battery can cause **Internal Chemical Burns** in as little as **2 hours**.
- **KEEP** new and used batteries **OUT OF REACH of CHILDREN**.
- **Seek immediate medical attention** if a battery is suspected to be swallowed or inserted inside any part of the body.



- a) Immediately dispose of used battery according to local regulations and keep it away from children. Do NOT dispose of the battery in household trash or incinerate.
- b) Even a used battery may cause severe injury or death.
- c) Call a local poison control center for treatment information.
- d) Battery type: MS414GE FL26E
- e) Nominal battery voltage: 3 V
- f) A non-rechargeable battery is not to be recharged.
- g) Do not force discharge, recharge, disassemble, heat above manufacturer's specified temperature rating, or incinerate the battery. Doing so may result in injury due to venting, leakage, or explosion, resulting in chemical burns.

## GENERAL CERTIFICATE OF CONFORMITY

PRODUCT MODEL	MODEL: R08050 TYPE: DIGITAL CAMERA
THE IMPORTER ISSUING THE CERTIFICATE	RICOH IMAGING AMERICAS CORPORATION 2 Gatehall Drive Suite 204, Parsippany, New Jersey 07054, U.S.A. (800) 234-0276
CONTACT INFORMATION FOR THE INDIVIDUAL MAINTAINING RECORDS OF TEST RESULTS	RICOH IMAGING AMERICAS CORPORATION Yuliana Kwok orders@ricoh-usa.com 2 Gatehall Drive Suite 204, Parsippany, New Jersey 07054, U.S.A. (905) 795-5729
TEST ITEM MODEL	R02050 Similar model: R08050
THE DATE AND PLACE OF MANUFACTURE	November, 2018 Jawa Barat, Indonesia
THE DATE AND PLACE WHERE THE PRODUCT WAS TESTED	18/1/2024 Tokyo, Japan
LABORATORY CONDUCTING TESTING ON WHICH THE CERTIFICATE DEPENDS	RICOH IMAGING COMPANY, LTD. 1-3-6, Nakamagome, Ohta-ku, Tokyo 143-8555, Japan



## For Customers in USA and Canada

Lithium-ion batteries are recyclable.

You can help preserve our environment by returning your used rechargeable batteries to the collection and recycling location nearest you.

For more information regarding recycling of rechargeable batteries, call toll free 1-800-822-8837, or visit <https://www.call2recycle.org/>.

## For Customers in Canada

### **Innovation, Science and Economic Development Canada (ISED) Regulatory Compliance Notice**

This Class B digital apparatus complies with Canadian ICES-003 (B).

This device contains licence-exempt transmitter(s)/receiver(s) that comply with Innovation, Science and Economic Development Canada's licence-exempt RSS(s). Operation is subject to the following two conditions:

1. This device may not cause interference.
2. This device must accept any interference, including interference that may cause undesired operation of the device.

The available scientific evidence does not show that any health problems are associated with using low power wireless devices. There is no proof, however, that these low power wireless devices are absolutely safe. Low power wireless devices emit low levels of radio frequency energy (RF) in the microwave range while being used. Whereas high levels of RF can produce health effects (by heating tissue), exposure of low-level RF that does not produce heating effects causes no known adverse health effects. Many studies of low-level RF exposures have not found any biological effects. Some studies have suggested that some biological effects might occur, but such findings have not been confirmed by additional research. The R08050 has been tested and found to comply with ISED radiation exposure limits set forth for an uncontrolled environment and meets RSS-102 of the ISED radio frequency (RF) Exposure rules.

### **CAUTION: RF Exposure**

To ensure compliance with the Radio Frequency (RF) exposure guidelines, this device must be used at least 5 mm away from your body or nearby persons. Failure to observe this warning could result in the RF exposure levels exceeding the applicable limits.

## **Pour les utilisateurs au Canada**

### **Avis de conformité à la réglementation d'Innovation, Sciences et Développement économique Canada (ISDE)**

Cet appareil numérique de la classe B est conforme à la norme NMB-003 (B) du Canada.

L'émetteur/récepteur exempt de licence contenu dans le présent appareil est conforme aux CNR d'Innovation, Sciences et Développement économique Canada applicables aux appareils radio exempts de licence. L'exploitation est autorisée aux deux conditions suivantes :

1. L'appareil ne doit pas produire de brouillage ;
2. L'appareil doit accepter tout brouillage radioélectrique subi, même si le brouillage est susceptible d'en compromettre le fonctionnement.

Les connaissances scientifiques dont nous disposons n'ont mis en évidence aucun problème de santé associé à l'usage des appareils sans fil à faible puissance. Nous ne sommes cependant pas en mesure de prouver que ces appareils sans fil à faible puissance sont entièrement sans danger. Les appareils sans fil à faible puissance émettent une énergie fréquence radioélectrique (RF) très faible dans le spectre des micro-ondes lorsqu'ils sont utilisés. Alors qu'une dose élevée de RF peut avoir des effets sur la santé (en chauffant les tissus), l'exposition à de faibles RF qui ne produisent pas de chaleur n'a pas de mauvais effets connus sur la santé. De nombreuses études ont été menées sur les expositions aux RF faibles et n'ont découvert aucun effet biologique. Certaines études ont suggéré qu'il pouvait y avoir certains effets biologiques, mais ces résultats n'ont pas été confirmés par des recherches supplémentaires. Le R08050 a été testé et jugé conforme aux limites d'exposition aux rayonnements ISDE énoncées pour un environnement non contrôlé et respecte les règles d'exposition aux fréquences radioélectriques (RF) CNR-102 de l'ISDE.

### **ATTENTION : Exposition aux RF**

Pour garantir la conformité avec les directives d'exposition aux fréquences radioélectriques (RF), cet appareil doit être utilisé à au moins 5 mm de votre corps ou des personnes se trouvant à proximité. Le non-respect de cet avertissement peut entraîner des niveaux d'exposition aux RF supérieurs aux limites applicables.

## For Customers in Europe

### Information for Users on Collection and Disposal of Old Equipment and Used Batteries



#### 1. In the European Union

These symbols on the products, packaging and/or accompanying documents mean that used electrical and electronic equipment and batteries should not be mixed with general household waste.

Used electrical/electronic equipment and batteries must be treated separately and in accordance with legislation that requires proper treatment, recovery and recycling of these products.



By disposing of these products correctly you will help ensure that the waste undergoes the necessary treatment, recovery and recycling and thus prevent potential negative effects on the environment and human health which could otherwise arise due to inappropriate waste handling.

If a chemical symbol is added beneath the symbol shown above, in accordance with the Battery Directive, this indicates that a heavy metal (Hg = Mercury, Cd = Cadmium, Pb = Lead) is present in the battery at a concentration above an applicable threshold specified in the Battery Regulation.

For more information about collection and recycling of used products, please contact your local authorities, your waste disposal service or the point of sale where you purchased the products.

#### 2. In other countries outside the EU

These symbols are only valid in the European Union. If you wish to discard used products, please contact your local authorities or dealer and ask for the correct method of disposal.

For Switzerland: Used electrical/electronic equipment can be returned free of charge to the dealer, even when you don't purchase a new product. Further collection facilities are listed on the home page of [www.swico.ch](http://www.swico.ch) or [www.sens.ch](http://www.sens.ch).

## Notice to Users in Countries that Require the CE Marking

This product complies with the essential requirements and provisions.

### RE Directive 2014/53/EU

The EU Declaration of Conformity is available by accessing the URL:  
[https://www.ricoh-imaging.co.jp/english/support/declaration\\_of\\_conformity.html](https://www.ricoh-imaging.co.jp/english/support/declaration_of_conformity.html)  
and selecting the product applicable.

Importer (CE Marking): RICOH IMAGING EUROPE S.A.S.  
7-9, avenue Robert Schuman, 94150 Rungis, FRANCE

Manufacturer: RICOH IMAGING COMPANY, LTD.  
1-3-6, Nakamagome, Ohta-ku, Tokyo 143-8555, JAPAN

### Battery Regulation (EU) 2023/1542

Importer (CE Marking): RICOH IMAGING EUROPE S.A.S.  
7-9, avenue Robert Schuman, 94150 Rungis, FRANCE  
<https://ricoh-imaging.eu/>

Manufacturer: RICOH IMAGING COMPANY, LTD.  
1-3-6, Nakamagome, Ohta-ku, Tokyo 143-8555, JAPAN  
<https://www.ricoh-imaging.co.jp/english/>



The CE Mark is a conformity mark of the European Union.

## Notice to Users in Countries that Require the UKCA Marking

This product complies with the essential requirements and provisions.

### Radio Equipment Regulations 2017

The UK Declaration of Conformity is available by accessing the URL:

[https://www.ricoh-imaging.co.jp/english/support/declaration\\_of\\_conformity.html](https://www.ricoh-imaging.co.jp/english/support/declaration_of_conformity.html)  
and selecting the product applicable.

Manufacturer : RICOH IMAGING COMPANY, LTD.

1-3-6, Nakamagome, Ohta-ku, Tokyo 143-8555, JAPAN



The UKCA Mark is a Regulation conformity mark of the United Kingdom.

## For Customers in Thai

This telecommunication equipment conforms to the requirements of the Office of the National Broadcasting and Telecommunications Commission.



n anb.

เครื่องวิทยุคมนาคมนี้ ได้รับยกเว้น ไม่ต้องได้รับ  
ใบอนุญาตให้มี ใช้ซึ่งเครื่องวิทยุคมนาคม  
หรือตั้งสถานีวิทยุคมนาคมตามประกาศ กสทช.  
เรื่อง เครื่องวิทยุคมนาคม และสถานีวิทยุ  
คมนาคมที่ได้รับยกเว้นไม่ต้องได้รับใบอนุญาต  
วิทยุคมนาคม ตามพระราชบัญญัติวิทยุ  
คมนาคม พ.ศ. 2498



n anb. | โทรคมนาคม  
กำกับดูแลเพื่อประชาชน  
Call Center 1200 ( 1นบ5 )

6

Appendix

# Index

## Numerics

1 cm Macro ..... 49

## A

A-Bracket ..... 61  
AC adapter ..... 101  
Adding title picture ..... 77  
ADJ. button ..... 20  
ADJ Button Setting ..... 82  
ADJ. mode ..... 20  
AE Metering ..... 52  
AF ..... 50  
Anti Red-eye (Flash) ..... 54  
Aspect Ratio ..... 62  
Assist (Face Detection) ..... 50  
Auto Image Rotation ..... 68  
AUTO ISO Range ..... 53  
Auto Macro ..... 49  
Auto mode ..... 38  
Auto Power Off ..... 86  
Auto WB (White Balance) ..... 56  
AV device ..... 69

## B

Battery ..... 31, 33  
Blink Detection ..... 38  
Bright (Image Tone) ..... 63  
Burst Shoot ..... 59  
Button ..... 14

## C

Calendar display ..... 66  
Calibrate Level ..... 84  
CALS mode ..... 40  
CALS Pixels ..... 40  
CALS Quality ..... 40  
Camera route ..... 90  
Camera Settings File ..... 81  
Capture mode ..... 40  
Card ..... 31  
Care ..... 118  
Center (AE Metering) ..... 52  
Certifications ..... 29  
Changing display ..... 18  
Charging the battery ..... 33  
Cloudy (White Balance) ..... 56

Compass Calibration ..... 92  
Compass Heading ..... 92  
Confirm. Time ..... 38  
Connection to a computer ..... 73  
Contrast ..... 64  
Cont. Shoot ..... 59  
Copyright Info ..... 97  
Correcting a range of tones ..... 65  
Cropping ..... 75  
Cursor Pos. Keeping ..... 23  
Customization ..... 82  
Customize menu ..... 27

## D

Data Imprint ..... 93  
Date and time setting ..... 36  
Date Imprint ..... 64  
Daylight (White Balance) ..... 56  
Declination ..... 92  
Delete ..... 39, 70  
Destination ..... 99  
Dial ..... 14  
Digital Filter ..... 76  
Digital microscope mode ..... 40  
Digital SR (Scene) ..... 41  
Digital zoom ..... 39  
Direct keys ..... 19  
Discard log data ..... 92  
Divide (AE Metering) ..... 52  
Divide Movies ..... 77  
DOF Composite (Scene) ..... 41  
D-Range Setting ..... 65  
Drive Mode ..... 58

## E

Editing images ..... 74  
Embed Info ..... 97  
EV Comp. ..... 43  
Exif ..... 97

## F

Face Detection ..... 50  
File name ..... 96  
File Sequence No. .... 96  
Filter ..... 76  
Fireworks (Scene) ..... 41  
Flash ..... 54  
FlashAir ..... 32  
Flash Off (Flash) ..... 54

Flash On (Flash).....	54
Flower (Scene).....	41
Fluorescent (White Balance).....	56
Fn button.....	21
Focus Assist.....	50
Focus Mode.....	49
Folder display.....	66
Format.....	37

## G

GPS.....	89
GPS Data Imprint.....	93
GPS Disp Mode.....	90
GPS Lock.....	90
GPS Log.....	90
GPS Time Adjustment.....	90
Green button.....	21, 83
Green Mode.....	40
Grid Guide Display Op.....	84
Guide Display.....	42

## H

Handheld Night Snap (Scene).....	41
HDMI®.....	69
HDR Filter.....	76
HDR (Movie).....	62
HDR (Scene).....	41
Heading Data Imprint.....	93
Highlight Cor.....	65
High Speed Movie (Scene).....	41

## I

Image Copy.....	71
Image Tone.....	63
Infinity (Focus).....	49
Initialized Setting.....	23
Initial settings.....	35
Ink Rubbing Filter.....	76
Instant Review.....	38
Intelligent zoom.....	39
Internal memory.....	32
Interval Movie (Scene).....	41
Interval Shooting (Scene).....	41
IQ Enhancer.....	64
ISO Setting.....	53

## K

Kids (Scene).....	41
-------------------	----

## L

Landscape (Scene).....	41
Language setting.....	36
LAT/LON (GPS).....	90
LCD Brightness.....	85
Lens Adapter On.....	100
Level Setting.....	84
Location Data.....	89

## M

Macro.....	49
Macro stand.....	11
Magnifying captured image.....	39
Manual Focus.....	51
Manual WB (White Balance).....	57
M-Cont.....	59
Memory card.....	31
Memory retrospective continuous shooting.....	59
Menu.....	22
MF (Focus).....	51
MGRS (GPS).....	90
Microphone.....	45, 62
Monitor.....	16
Monitor Auto off Delay.....	86
Monochrome (Image Tone).....	63
Movie.....	44
Movie Button.....	20
Movie Edit.....	77
Movie menu.....	25
Movie SR.....	65
Multi (AF).....	50
Multiple image display.....	66

## N

Natural (Image Tone).....	63
New folder options.....	94
Night Scene (Scene).....	41

## O

Operating environment.....	113
Operation Volume.....	85
Optical zoom.....	39
Outdoor View.....	85

## P

Package contents.....	11
Pet (Scene).....	41



PF (Focus).....	49	Show folder at startup.....	84
Pix. Track SR.....	65	Shut-down Screen.....	84
Playback.....	39, 66	Single image display.....	39
Playback menu.....	26	Slide Film (Image Tone).....	63
Playback Volume.....	85	Slideshow.....	67
P mode.....	40	Small Face Filter.....	76
Portrait (Scene).....	41	Smile (Face Detection).....	50
Power.....	35	Sound.....	85
Power Button Hold Op.....	35	Sound volume.....	85
Power Button Lamp.....	35, 85	Specifications.....	108
Power Saving.....	86	Sport (Scene).....	41
Processing images.....	74	Spot (AE Metering).....	52
Program mode.....	40	Spot (AF).....	50
Protect.....	72	START DATE/TIME.....	84
<b>Q</b>		Start-up Screen.....	84
Quality Level.....	62	Storage.....	118
Quick Zoom.....	39	Storage capacity.....	34, 112
<b>R</b>		Streaming continuous shooting.....	59
Recorded Pixels.....	62	Surf & Snow (Scene).....	41
Record log.....	90	<b>T</b>	
Recover File.....	71	Thumbnail display.....	66
Red-eye Edit.....	79	Tone Adjustment.....	64
Reg. USER.....	80	Tracking (AF).....	50
Remote Ctl.....	60	Tungsten (White Balance).....	57
Reset.....	23	TV.....	69
Reset File Number.....	97	<b>U</b>	
Resize.....	74	Underwater Movie (Scene).....	41
Ring Light.....	55	Underwater (Scene).....	41
Ring Light (White Balance).....	55	USB cable.....	73
Rotation.....	68	USB Connection.....	73
<b>S</b>		USB power adapter.....	33
Saturation.....	64	User mode.....	80
Save as Still Image.....	77	UTC Data Imprint.....	93
Save log data.....	92	UTM (GPS).....	90
Saving power.....	86	UVC.....	47
Scene mode.....	41	<b>V</b>	
SCN mode.....	41	Version Info.....	29
S-Cont.....	59	Vibrant (Image Tone).....	63
SD memory card.....	31	<b>W</b>	
Self-timer.....	58	Warranty Policy.....	120
Sensitivity.....	53	Webcam.....	47
Setup menu.....	29	White Balance.....	56
Shade (White Balance).....	56	Wide conversion lens.....	100
Shadow Cor.....	65	Wind Suppression.....	62
Sharpness.....	64	World Time.....	99
Shooting menu.....	24		

## **Z**

Zoom..... 39

# RICOH

## **RICOH IMAGING COMPANY, LTD.**

1-3-6, Nakamagome, Ohta-ku, Tokyo 143-8555,  
JAPAN  
(<https://www.ricoh-imaging.co.jp/english/>)

## **RICOH IMAGING EUROPE S.A.S.**

7-9, avenue Robert Schuman, 94150 Rungis,  
FRANCE  
(<https://www.ricoh-imaging.eu>)

## **RICOH IMAGING AMERICAS CORPORATION**

2 Gatehall Drive Suite 204, Parsippany, New Jersey  
07054, U.S.A.  
(<https://www.us.ricoh-imaging.com>)

## **RICOH IMAGING CANADA INC.**

5560 Explorer Drive Suite 100, Mississauga, Ontario,  
L4W 5M3, CANADA  
(<https://www.ricoh-imaging.ca>)

## **RICOH IMAGING CHINA CO., LTD.**

Room A 23F Lansheng Building, 2-8 Huaihaizhong  
Road, Huangpu District, Shanghai, 200021, CHINA  
(<https://www.ricoh-imaging.com.cn/china/>)

**<https://www.ricoh-imaging.co.jp/english/>**

This contact information may change without  
notice. Please check the latest information on our  
websites.

RICOH IMAGING COMPANY, LTD.  
May, 2024



EN (USA) GB (GB) AE (AE)

Printed in Indonesia  
1AG6P1P7412--